





1965

CORVETTE

SPECIFICATIONS

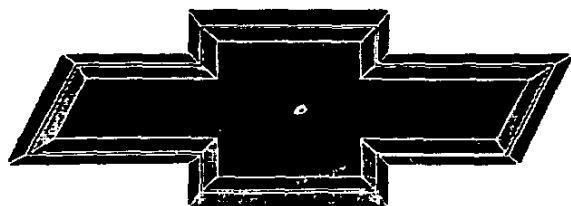
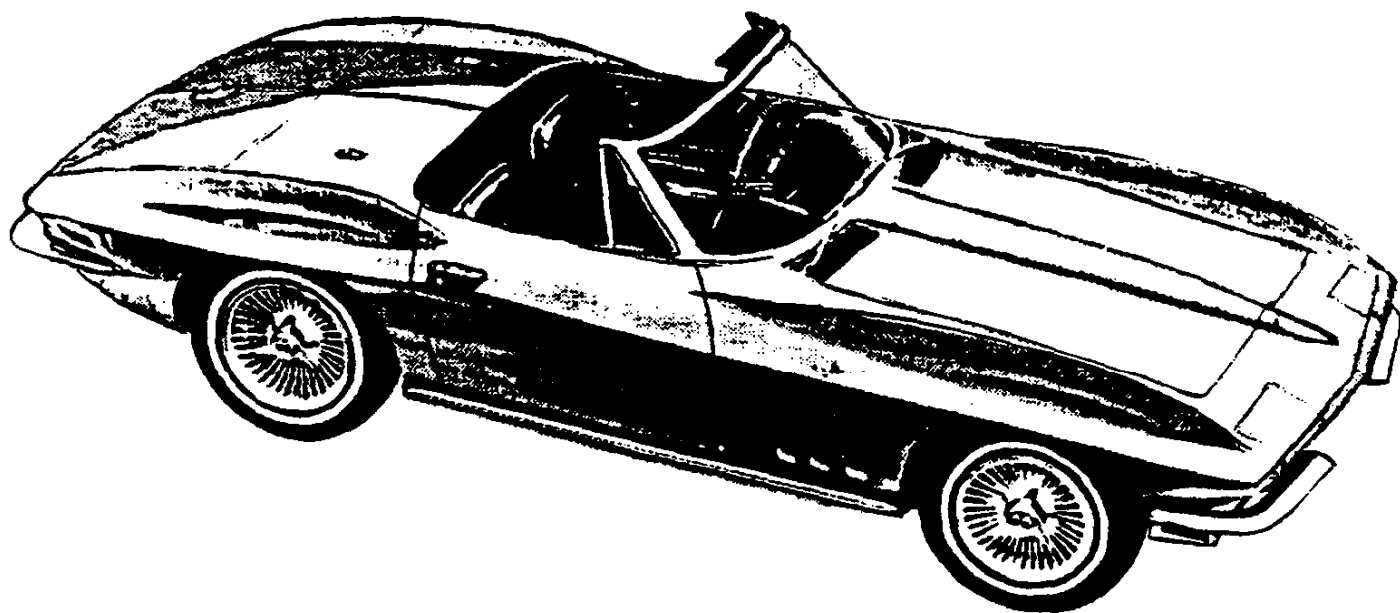

GENUINE CHEVROLET™

•
•
•

1965 CORVETTE

Production: 8,186 coupe, 15,376 convertible, 23,562 total.

1965 NUMBERS

Vehicle: 194375S100001 through 194375S123562
 * For convertibles, fourth digit is a 6.

Suffix: HE: 327ci, 250hp, mt HO: 327ci, 250hp, at
 HF: 327ci, 300hp, mt HP: 327ci, 300hp, at
 HG: 327ci, 375hp, mt HQ: 327ci, 250hp, at, ac
 HH: 327ci, 365hp, mt HR: 327ci, 300hp, at, ac
 HI: 327ci, 250hp, mt, ac HT: 327ci, 350hp, mt
 HJ: 327ci, 300hp, mt, ac HU: 327ci, 350hp, mt, ac
 HK: 327ci, 365hp, mt, ac HV: 327ci, 350hp, mt, ig
 HL: 327ci, 365hp, mt, ig HW: 327ci, 350hp, mt, ac, ig
 HN: 327ci, 375hp, mt, ig IF: 396ci, 425hp, mt, ig

Block: 3782870: 327ci 3855962: 396ci 3858180: 327ci (lu)
 Head: 3782461: 327ci 3856208: 396ci

Carburetor: Carter 3696S #3846246: 327ci, 250hp, at
 Carter 3697S #3846247: 327ci, 250hp, mt
 Carter 3720SB #3851762: 327ci, 300hp, at
 Carter 372ISB #3851761: 327ci, 300hp, mt
 Holly R2818A #3849804: 327ci, 350hp, 365hp
 Holly R3124A #3868826: 396ci, 425hp

Fuel Injection: Rochester 7017380

Distributor: 111060: 327ci, 365hp, ig 1111076: 327ci, 250hp, 300hp
 1111064: 327ci, 375hp, ig 1111087: 327ci, 350hp
 1111069: 327ci, 365hp 1111088: 327ci, 350hp, ig
 1111070: 327ci, 375hp 1111093: 396ci, 425hp, ig

Alternator: 1100593: 327ci 1100699: 327ci, 396ci, ig
 1100594: 327ci, ac 1100697: 327ci, 350hp, 365hp, ac, ig

Ending Vehicle: Aug 64: 100227 Jan 65: 109842 May 65: 118753
 Sep 64: 101425 Feb 65: 111059 Jun 65: 121216
 Nov 64: 103347 Mar 65: 113936 Jul 65: 123562
 Dec 64: 105754 Apr 65: 116516 Aug 65: 123564

Abbreviations: ac=air conditioning, al=automatic transmission, ci=cubic inch, hp=horsepower, ig=transistor ignition, lu=limited use, mt>manual transmission.

1965 FACTS

- Appearance changes included a restyle of the side front tender louvers as three functional, vertical slots. Hood/recesses were removed. Horizontal grill bars changed to black, but outer trim rings remained bright.
- The vehicle identification number (VIN) of the last 1965 Corvette built ended in 23,564, two units higher than the 23,562 total build figure. (It isn't certain if the total is wrong, or if two VINs weren't used.)
- This was the last year for fuel injection in Corvettes until throttle-body injection in 1982. In mid-March 1965, the big-block option was unveiled, limited to a 396ci, 425hp version which came with a special hood.
- Four-wheel disc brakes were introduced as standard equipment for 1965 Corvettes. Drum brakes were a cost-delete option while supplies lasted.
- Instruments were done in a black, flat-face style. The area around the radio and speaker bezel was painted, rather than vinyl-covered.
- Seats and inner door panels were redesigned for 1965 Corvettes.
- Optional knock-off wheels were dark grey between the fins.

1965 OPTIONS

RPO #	DESCRIPTION	QTY	RETAIL \$
19437	Base Corvette Sport Coupe	8,186	\$4,321.00
19438	Base Corvette Convertible	15,376	4,106.00
19467	Genuine Leather Seats	2,128	80.70
A01	Soft Ray Tinted Glass, all windows	8,752	16.15
A02	Soft Ray Tinted Glass, windshield	7,624	10.80
A31	Power Windows	3,809	59.20
C07	Auxiliary Hardtop (for convertible)	7,787	236.75
C48	Heater and Defroster Deletion (credit)	39	-100.00
C60	Air Conditioning	2,423	421.80
F40	Special Front and Rear Suspension	975	37.70
G81	Postraction Rear Axle, all ratios	19,965	43.05
G91	Special Highway Axle, 3.08:1 ratio	1,886	2.20
J50	Power Brakes	4,044	43.05
K61	Drum Brakes (substitution credit)	316	-64.50
K66	Transistor Ignition System	3,686	75.35
L75	327ci, 300hp Engine	8,358	53.80
L76	327ci, 365hp Engine	5,011	129.15
L78	396ci, 425hp Engine	2,157	292.70
L79	327ci, 350hp Engine (fuel injection)	4,716	107.60
L84	4-Speed Manual Transmission	21,107	538.00
M20	Powerglide Automatic Transmission	2,102	188.30
M35	36 Gallon Fuel Tank (for coupe)	41	199.10
N03	Oil Road Exhaust System	2,468	202.30
N11	Side Mount Exhaust System	759	37.70
N14	Teakwood Steering Wheel	2,259	134.50
N32	Telescopic Steering Column	3,917	48.45
N36	Power Steering	3,236	43.05
N40	Cast Aluminum Knock-Off Wheels (5)	1,116	96.85
P48	Blackwall Tires, 7.75x15 (nylon cord)	168	322.80
P91	Blackwall Tires, 7.75x15 (rayon cord)	19,300	15.70
P92	Goldwall Tires, 7.75x15 (nylon cord)	989	31.85
T01	AM-FM Radio	22,113	50.05
U69	Confort and Convenience Group	15,397	203.40
Z01	A 327ci, 250hp engine, 3-speed manual transmission, vinyl interior trim, and soft top (convertible) were included in the base price at no extra cost.		16.15

1965 COLORS

CODE	EXTERIOR	QTY	SOFT TOP	WHEELS	INTERIORS
AA	Tuxedo Black	1,191	Bk-W-Bg	Black	Bk-B-G-M-R-S-Si-W
CC	Ermine White	2,216	Bk-W-Bg	Black	Bk-B-G-M-R-S-Si-W
FF	Nassau Blue	6,022	Bk-W-Bg	Black	Bk-B-W
GG	Glen Green	3,782	Bk-W-Bg	Black	Bk-G-S-W
MM	Milano Maroon	2,891	Bk-W-Bg	Black	Bk-R-M-S-W
QQ	Silver Pearl	2,552	Bk-W-Bg	Black	Bk-R-Si
UU	Rally Red	3,688	Bk-W-Bg	Black	Bk-R-W
XX	Goldwood Yellow	1,275	Bk-W-Bg	Black	Bk-W

• Suggested interiors shown. Other combinations were possible.
 • In 1965, 5 Corvettes had non-standard paint, or primer.
 Interior Codes: Sid=Bk/V, 402=Bk/L, 407=R/V, 408=R/L, 414=B/V, 415=B/L, 420=S/V, 421=SL, 426=Si/V, 427=Si/L, 430=G/V, 431=G/L, 435=M/V, 436=M/L, 437=W+Bk/V, 438=W+B/L, 443=W+R/V, 444=W+R/L, 450=W+B/V, 451=W+B/L.

Abbreviations: B=Blue, Bg=Beige, Bk=Black, G=Green, L=leather, M=Maroon, R=Red, S=Saddle, Si=Silver, V=Vinyl, W=White.

BLACK BOOK ORDER FORM

Send _____ copies of the

Corvette Black Book 1953-1995

@ \$11.95 each \$ _____

Ohio residents add .72 sales tax _____

Postage/hard shipping container 3.00

Check or money order enclosed \$ _____

Name _____

Street _____

City _____ State _____ Zip _____

Mail Order To: **Michael Bruce Associates, Inc.**
Post Office Box 396
Powell, Ohio 43065



BLACK BOOK ORDER FORM

Send _____ copies of the

Corvette Black Book 1953-1995

@ \$11.95 each \$ _____

Ohio residents add .72 sales tax _____

Postage/hard shipping container 3.00

Check or money order enclosed \$ _____

Name _____

Street _____

City _____ State _____ Zip _____

Mail Order To: **Michael Bruce Associates, Inc.**
Post Office Box 396
Powell, Ohio 43065

CORVETTE

1965 MODEL CORVETTE WITH STANDARD EQUIPMENT (250-hp Corvette V8 Engine—98" Wheelbase)

Model Description	Price at which Dealer is Invoiced (List Price less 23%) †	Factory D & H	List Price	Mfr's Sgr'd Dealer D & H	Mfr's Sgr'd Retail Price*	Destination Charge	Total
19437 Corvette Sport Coupe 2-door—2-passenger.....				\$40.00	\$4233.00		
19467 Corvette Convertible—2-passenger With manually operated soft top.....				40.00	4022.00		

† Base discount is 25% with the 2% difference retained for dealer's account in accordance with Dealer Price List.
* Manufacturer's Suggested Retail Price does not include state and local taxes, license fees, options or accessories.

FACTORY INSTALLED REGULAR PRODUCTION TUBELESS TIRES

Description	Option Number	Dealer Net	Factory D & H	List Price	Mfr's Suggested Retail Delivered Price◇
(5) 7.75-15/4-ply Regular Highway Blackwall.....	Std				N.C.
(5) 7.75-15/4-ply Regular Highway Whitewall.....	P92				\$ 31.25
(5) 7.75-15/4-ply Nylon Highway Goldwall.....	T01				48.50

◇ State and local taxes not included.

OPTIONS & ACCESSORIES WHEN INSTALLED BY CHEVROLET

Description	Option Number	Dealer Net	Factory D & H	List Price	Mfr's Suggested Retail Delivered Price◇
Air Conditioning, Four-Season: With 250-hp, 300-hp, 350-hp or 365-hp engine only.....	C60				\$412.85
Axle, Rear: 3.08 ratio (4-spd trans with 250-hp or 300-hp engine).....	G91				2.10
Axle, Positraction Rear: See Power Teams chart for availability					
3.08 ratio.....	G81				42.10
3.36 ratio.....	G81				42.10
3.55 ratio.....	G81				42.10
3.70 ratio.....	G81				42.10
4.11 ratio.....	G81				42.10
4.56 ratio.....	G81				42.10
Brakes, Conventional Drum & Shoe Type: Replaces standard front and rear disc brakes.....	J61				63.15 CR.
Brakes, Vacuum Power: Includes dual circuit master cylinder.....	J50				42.10
Comfort & Convenience Equipment: Includes back-up lamps and inside prismatic rearview mirror.....	Z01				15.80
Engine: 327-cu-in displacement on 300-, 350-, 365- & 375-hp					
300-hp Corvette V8—large 4-barrel carburetor (Regular camshaft).....	L75				52.65
350-hp Corvette V8—large 4-barrel carburetor; hyd lifters (High-lift camshaft).....	L79				105.30
365-hp Corvette V8—large 4-barrel carburetor (High-lift camshaft).....	L76				126.40
375-hp Corvette V8—Fuel Injection (High-lift camshaft).....	L84				526.60
425-hp Turbo-Jet 396-cu-in displacement V8—Available only when Positraction rear axle & transistorized ignition system are ordered.....	L78				286.45

◇ State and local taxes not included.

CORVETTE

OPTIONS AND ACCESSORIES WHEN INSTALLED BY CHEVROLET (Cont'd)

Description	Option Number	Dealer Net	Factory D & H	List Price	Mfr.'s Suggested Retail Delivered Price [◇]
Exhaust System: Off-road service—Available only when optional engine & 4-speed transmission are ordered.	N11				\$ 36.85
Exhaust System, Dual Side Mounted: (For off-road service only). Available only when optional engine & 4-speed transmission are ordered.	N14				131.65
Glass, Soft Ray Tinted: Windshield only.	A02				10.55
All windows.	A01				15.80
Heater and Defroster Deletion: Not available with air conditioning	C48				97.90 CR.
Ignition System: (Full-transistor) with 350-hp, 365-hp, 375-hp or 425-hp engines only. For detailed description see 1965 <i>Finger-Tip Facts</i> book.	K66				73.70
Paint, Exterior: Solid colors only. See Color and Trim chart.					N.C.
Radio, AM-FM: Pushbutton control (Includes power antenna).	U69				199.05
Special Front & Rear Suspension: Includes HD front & rear springs, HD front & rear shock absorbers and HD front stabilizer bar (available only when 375-hp or 425-hp engines, 4-speed transmission and Positraction rear axle are ordered which must be shown separately on order form and will be invoiced as individual options).	F40				36.85
Steering, Power: With 250-hp, 300-hp or 350-hp engines only.	N40				94.75
Steering Shaft, Telescopic	N36				42.10
Steering Wheel, Wood	N32				47.40
Tank, Fuel: Model 19437 only (Capacity 36 gal) *Also includes wheelhouse filler panel and a color-keyed fiber glass protective cover over tank in place of luggage compartment carpet.	N03				198.00
Top, Auxiliary: Hard top; Model 19467 only In place of folding top.	C07				N.C.
In addition to folding top.	C07				231.70
Top, Folding: Model 19467 only. White or beige (Standard color is black).	C05				N.C.
Transmission: See Power Teams chart for availability <i>4-Speed Synchro-Mesh</i>	M20				184.30
<i>Powerglide</i> (With 250-hp or 300-hp engine only).	M35				194.85
<i>4-Speed Heavy-Duty</i>	M22				236.95
Trim Combinations: See Color and Trim chart Genuine leather seats.					78.95
All other trims.					N.C.
Wheels: Five cast-aluminum 15 x 6L quick knock-off type.	P48				315.95
Windows, Power: Electric control.	A31				57.90

◇ State and local taxes not included.

CORVETTE POWER TEAMS

ENGINE, TRANSMISSION & REAR AXLE COMBINATIONS

ENGINE			REAR AXLE RATIOS			
			Standard		Optional	
Option Number	Description	TRANSMISSION	General Purpose	Special Purpose or Mountain★	Performance Cruise	High Performance★
Standard	250-hp Corvette V8 327-cu-in displacement 4-barrel carburetor Hydraulic lifters 10.5:1 compression ratio	3-Speed	3.36:1 ▲		3.08:1 (RPO G91)▲	
		4-Speed Wide-Range				
		Powerglide				
L75	300-hp Corvette V8 327-cu-in displacement Large 4-barrel carburetor Hydraulic lifters 10.5:1 compression ratio	4-Speed Wide-Range	3.36:1 ▲		3.08:1 (RPO G91)▲	
		Powerglide				
L79	350-hp Corvette V8 327-cu-in displacement Large 4-barrel carburetor Special camshaft Hydraulic lifters 11.0:1 compression ratio	4-Speed Close-Ratio●	3.70:1 ▲	4.11:1	3.55:1★	
L76	365-hp Corvette V8 327-cu-in displacement Large 4-barrel carburetor Special camshaft Mechanical lifters 11.0:1 compression ratio	4-Speed Close-Ratio●	3.70:1 ▲	4.11:1	3.08:1★ 3.36:1★ 3.55:1★	4.56:1
L84	375-hp Ramjet Fuel Injection V8 327-cu-in displacement Special camshaft Mechanical lifters 11.0:1 compression ratio	4-Speed Close-Ratio●	3.70:1 ▲	4.11:1	3.08:1★ 3.36:1★ 3.55:1★	4.56:1
L78	425-hp Turbo-Jet 396 V8 396-cu-in displacement 4-barrel carburetor Special camshaft Mechanical lifters 11.0:1 compression ratio	4-Speed Close-Ratio	3.36:1★	4.11:1	3.08:1★ 3.55:1★ 3.70:1★	4.56:1

★ Available as Positraction only (RPO G81) ▲ Also available as Positraction (RPO G81)

● A 4-speed wide-range transmission (2.56 low gear ratio) may be obtained on Special Order with a 3.08, 3.36, 3.55, 3.70 or 4.11 rear axle ratio.

CORVETTE

Important Information Concerning Ordering Interior Trim and Exterior Colors

1965 CORVETTE DEALER ORDER No.

TO COMPLETE ORDER CORRECTLY PLEASE PRINT AND CHECK THIS ORDER CAREFULLY TO BE SURE TO BE SURE TO USE CORRECT COLOR CODES.

DEALER NAME: _____ STOCK SOLD DATE: _____

STREET ADDRESS: _____ CUSTOMER NAME: _____

CITY & STATE: _____ DEALER SIGNATURE: _____

MODEL	EXTERIOR COLOR	TRIM	TOP	OPTIONAL EQUIPMENT	PRICE
X 1965-CORVETTE	<i>Rally Red</i>	<i>UV</i>	<i>Black</i>	<i>K</i>	
1965-CONVERTIBLE					

OPTIONAL EQUIPMENT

DESCRIPTION	PRICE
FORWARD TRANSMISSION	190
3 SPEED SYNCHRONOUS TRANSMISSION	190
4 SPEED SYNCHRONOUS TRANSMISSION	240
280 H.P. 4 BARREL CARBURETOR	140
280 H.P. LARGE 4 BARREL CARBURETOR	175
280 H.P. LARGE 4 BARREL CARBURETOR	175
280 H.P. FULL THROTTLE	140
POSTRACKION 3.58 TO 1	140
POSTRACKION 3.26 TO 1	140
POSTRACKION 3.16 TO 1	140
POSTRACKION 2.11 TO 1	140
POSTRACKION 1.56 TO 1	140
POSTRACKION 1.36 TO 1	140
POWER STEERING	140
POWER GRANGE	140

MODEL	EXTERIOR COLOR	TRIM	TOP	OPTIONAL EQUIPMENT	PRICE
X 1965-CORVETTE	<i>Rally Red</i>	<i>UV</i>	<i>Black</i>	<i>K</i>	
1965-CONVERTIBLE					

Explanation of Exterior Color Identification	All exterior paints are now identified by alphabetical color codes. All color codes are double letters. See sample above. Two-tone exteriors are not available on Corvettes.
Explanation of Interior Trim Identification	Ordering codes remain single alphabetical letters (SEE CHART ON OPPOSITE PAGE). Trim option numbers are for invoicing only to denote color of trim.

PLEASE GIVE SPECIAL ATTENTION TO THE FOLLOWING

SERIES	REMARKS
CORVETTE	White/Red Trim: Instrument panel and carpet are red. White/Blue Trim: Instrument panel and carpet are medium blue. White/Black Trim: Instrument panel and carpet are black. Silver Trim: Instrument panel is black and carpet is dark gray. Convertible Tops: Black-Beige-White. Each is available with all exterior colors. NOTE: Leather interior—seats only are genuine leather.

CORVETTE COLOR & TRIM CHART

INTERIOR TRIM CODES			EXTERIOR COLORS								
The following code must be shown on the order form for the desired interior trim. LEATHER VINYL K — E — BLACK J — C — SADDLE M — D — RED N — B — BLUE P — Y — SILVER/BLACK L — X — GREEN V — Z — MAROON S — F — WHITE/BLACK T — Q — WHITE/RED U — H — WHITE/BLUE			Tuxedo Black	Ermine White	Rally Red	Nassau Blue	Goldwood Yellow	Silver Pearl	Glen Green	Milano Maroon	
MODELS	Int. Trim & RPO	Exterior Code	AA	CC	UU	FF	XX	QQ	GG	MM	
CONVERTIBLE 19467 SPORT COUPE 19437	L E A T H E R	Black	402	K	K	K	K	K	K	K	
		Red	408	M	M	M			M		
		Blue	415	N	N		N				
		Saddle	421	J	J					J	J
		Silver/Black	427	P	P				P		
		Green	431	L	L					L	
		White/Black	438	S	S	S		S		S	S
		White/Red	444	T	T	T					
		White/Blue	451	U	U		U				
		Maroon	436	V	V						V
CONVERTIBLE 19467 SPORT COUPE 19437	V I N Y L	Black	Std	E	E	E	E	E	E	E	
		Red	407	D	D	D			D		
		Blue	414	B	B		B				
		Saddle	420	C	C					C	C
		Silver/Black	426	Y	Y				Y		
		Green	430	X	X					X	
		White/Black	437	F	F	F		F		F	F
		White/Red	443	Q	Q	Q					
		White/Blue	450	H	H		H				
		Maroon	435	Z	Z						Z



GENERAL

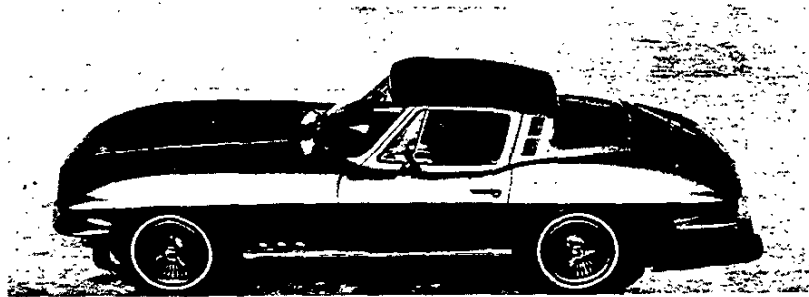

MODEL IDENTIFICATION	2
SERIAL NUMBERS AND IDENTIFICATION	2
REGULAR EQUIPMENT - INTERIOR	3
REGULAR EQUIPMENT - EXTERIOR	4
REGULAR PRODUCTION OPTIONS	5
DEALER INSTALLED ACCESSORIES	5
INTERIOR DIMENSIONS	6
EXTERIOR DIMENSIONS	7
VEHICLE WEIGHTS	8
EXTERIOR PAINT PROCESS	8
EXTERIOR-INTERIOR COLOR COMBINATIONS	9
BODY GLASS	9
BODY CONSTRUCTION	10

MODEL IDENTIFICATION

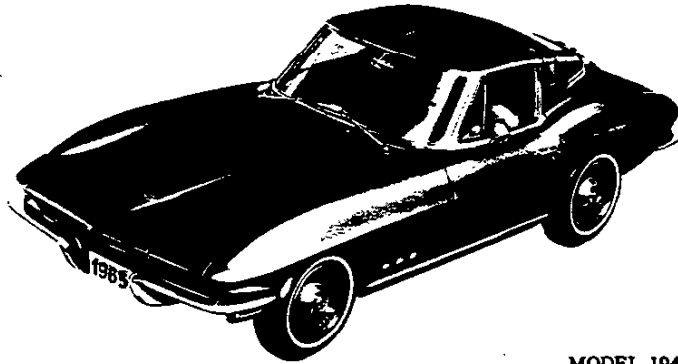

MODEL 19437
2-PASSENGER SPORT COUPE

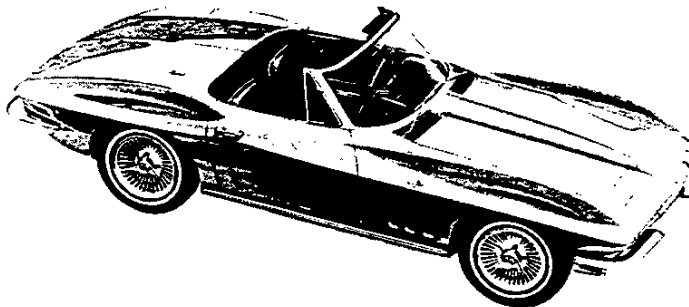

MODEL 19467
2-PASSENGER CONVERTIBLE

SERIAL NUMBERS AND IDENTIFICATION

ENGINE IDENTIFICATION

Description ----- Engine identification describes three aspects - where the engine was built, the month and day it was built, and the type of engine. Every Corvette engine is assembled in Flint.

Description symbols

Assembly plant code (for Flint) ----- F
Month and day code ----- To be designated as numerals ("0" before any month or day not two numerals.)

Engine type code

Regular production engine -----	HE
RPO 2-L75 engine -----	HF
RPO 2-L79 engine -----	HT
RPO 2-L76 engine -----	HH
RPO 2-L84 engine -----	HG
Regular production engine with Powerglide ----	HO
RPO 2-L75 engine with Powerglide -----	HP
● RPO 2-L78 engine with 4-speed -----	IF

Example: A RPO 2-L84 Corvette engine built December 10th would bear engine identification F1210HG; if an RPO 2-L75 engine with Powerglide built June 1st, the engine identification would be F0601HP.

VEHICLE SERIAL NUMBER

Description ----- The vehicle serial number describes four aspects of the automobile - type of vehicle (passenger vs. truck), the model, the year it was built, and the number of the unit built.

Description symbols

Type of vehicle -----	1
Model symbol -----	9467 or 9437
Production year symbol for 1965 -----	5
Number of unit built -----	In numerical sequence beginning with 100001

Example: The 2000th, 1965 Corvette produced, if it was a model 19467, would bear serial number 194675102000.

REGULAR PRODUCTION OPTIONS

BODY OPTIONS

Air conditioning	C60	All models
Auxiliary top equipment	C07	Model 19467
Comfort and convenience	Z01	All models
Folding top	C05	Model 19467
Less heater equipment	C48	
Power windows	A31	
Radio, AM-FM (remote control antenna)	U69	All models
Tinted body glass	A01	
Tinted windshield	A02	
Wood steering wheel	N32	

ENGINE OPTIONS

● Engine, 425 HP	L78	All models
Engine, 300 HP	L75	
Engine, 350 HP	L79	
Engine, 375 HP	L84	
Gasoline tank, 36.5 gallon	N03	Model 19437
Off-road exhaust equipment	N11	All models
Side mounted exhaust system	N14	
Transistor ignition equipment	K66	

CHASSIS OPTIONS

● Brakes	Heavy duty	J56	All models
	Drum type (delete disc type)	J61	
	Power with drum or disc	J50	
Power steering	N40		
Rear axles	Positraction	G81	
	3.08:1	G91	
Special front and rear suspension equipment	F40		
Telescoping shaft steering	N36		
Tires	7.75 x 15 rayon, whitewall	P92	
	7.75 x 15 nylon N44 cord, gold stripe	T01	
15 x 6L wheel (quick take-off)	P48		

TRANSMISSION OPTIONS

4-speed	M20	All models
Automatic	M35	

DEALER INSTALLED ACCESSORIES

Antenna, radio (remote control)	All
Fire extinguisher	
Floor mat (clear vinyl)	
Gas cap, locking	
Mirror, (glare proof) rear view	
Radio, AM-FM	
Radio shielding installation unit	
Spotlamp, portable	
Tool kit	
Compass	
Luggage straps	
Tissue dispenser	

INTERIOR DIMENSIONS

	Code*	Description*	Models			
			19437	19467 Soft-top	19467 Hardtop	
FRONT COMPARTMENT	L31	Body zero line to H point	44.5			
	H70	Body zero line to H point	7.7			
	H61	Effective head room	37.0	38.5		
	H37	Headlining to roof height	.38	--	.33	
	L34	Maximum effective leg room - accelerator	42.7			
	H30	H point to heel point	3.9			
	H67	Depressed floor covering thickness	.31			
	L40	Back angle (degrees)	28			
	L42	Hip angle (degrees)	102			
	L44	Knee angle (degrees)	135			
	L46	Foot angle (degrees)	82			
	H65	D point differential, side to center	--			
	H54	D point to tunnel	1.9			
	L53	H point to accelerator floor point	35.8			
	L17	H point travel	4.0			
	H58	H point rise	.32			
	H5	H point to ground	15.4	15.4		
	SEAT AND ENTRANCE - FRONT	W3	Shoulder room	48.4		
		W5	Hip room	50.9		
W16		Seat width (each seat)	21.6			
H50		Upper body opening to ground	46.8	45.6		
H11		Entrance height	31.4	30.2		
H115		Step height (design load)	14.0			
H130		Step height (curb load)	16.2			
L18		Entrance foot clearance	16.5			
H32		Seat cushion deflection	3.1			
L14		Seat back thickness	3.9			
W1		Hat room	45.1	39.3		
H3		Seat chair height	9.0			
H26		Interior body height, M/M @ car Centerline	36.2	36.9	35.8	
H27		Interior body, M/M @ C/LO	40.7	41.6	40.6	
VISION AND CONTROL	H6	H point to W/S bottom DLO	19.9			
	H64	H point to W/S upper DLO	30.6			
	L49	H point to W/S upper DLO	16.4			
	H25	Belt height	18.0			
	W7	Steering wheel center to car Centerline	12.8			
	W9	Steering wheel maximum OD	16.0			
	H18	Steering column angle (degrees) - horizontal	16.45			
	H49	H point to top of steering wheel	23.3			
	L7	Steering wheel torso clearance	13.2			
	H13	Steering wheel thigh clearance	4.5			
	L13	Brake pedal knee clearance	24.6			
	L52	Brake pedal to accelerator	2.8			
W122	Tumble-home (degrees)	20.0				

* Code and description conform generally to AMA Specifications.

EXTERIOR DIMENSIONS

		Models		
		19437	19467 Soft-top	19467 Hardtop
WIDTH	Code *	Description *		
	W101	Tread - front		
	W102	Tread - rear		
	W103	Max. overall car width		
	W116	Max. overall body width		
	W106	Front fender overall width		
	W107	Rear fender overall width		
	W120	Max. overall width - doors open		
HEIGHT	H101	Overall height		
	H114	Hood at rear to ground		
	H112	Rocker panel to ground - front		
	H111	Rocker panel to ground - rear		
	H132	Bottom of door to ground, open		
	H133	Bottom of door to ground, closed		
	H122	W/S slope angle (degrees)		
	H136	Body zero to ground - front		
	H137	Body zero to ground - rear		
	H125	Headlamp to ground		
	H126	Tail lamp to ground		
	H158	Roof thickness		
	H159	DLO height		
H160	Body thickness			
LENGTH	L30	Body zero line to actual front of dash		
	L101	Wheelbase		
	L104	Overhang - front		
	L105	Overhang - rear		
	L103	Overall length		
	L128	Hood length at car C/L		
	L123	Body upper structure length @ car C/L		
	L129	Deck length @ car C/L		
	L127	Body zero line to C/L rear wheels		
	L130	Body zero line to W/S cowl point		
	L102	Tire size		
CLEARANCE AND GLASS AREA-HEIGHT	H102	Front bumper to ground		
	H104	Rear bumper to ground		
	H106	Angle of approach (degrees)		
	H107	Angle of departure (degrees)		
	H147	Ramp breakover angle (degrees)		
	H148	Front suspension to ground		
	H149	Oil pan to ground		
	H150	Flywheel housing to ground		
	H151	Frame structure to ground		
	H152	Exhaust system to ground		
	H153	Rear axle differential to ground		
	H154	Fuel tank to ground		
	H155	Spare tire well to ground		
	H156	Minimum running ground clearance		
SI	Windshield glass area (sq. inches)			

* - Code and Description conform generally to AMA Specifications.

VEHICLE WEIGHTS

VEHICLE WEIGHTS, LB

Weight of basic vehicle - 250 HP engine and
3-speed transmission

Model 19467 soft top	
Shipping weight	
Front -----	1520
Rear -----	1465
Total -----	2985
Curb weight	
Front -----	1520
Rear -----	1625
Total -----	3145
Design weight	
Front -----	1600
Rear -----	1845
Total -----	3445
Model 19437 Sport Coupe	
Shipping weight	
Front -----	1550
Rear -----	1430
Total -----	2980
Curb weight	
Front -----	1545
Rear -----	1590
Total -----	3135
Design weight	
Front -----	1625
Rear -----	1810
Total -----	3435
Model 19467 hardtop -----	Add 8 lb to soft top values
Powerglide transmission -----	Add 23.3 lb

EXTERIOR PAINT PROCESS

1. PRIMARY SANDING . . . All body panels and bonded joints that receive acrylic lacquer are dry sanded to prepare surfaces for painting. A filler material, called putty rub, is applied to the entire body to fill minor imperfections.
2. PRIMER . . . Two coats of primer are applied -- the first red and the second gray -- and are oven baked for 60 minutes at 280 degrees F.
3. WET SANDING . . . The body is wet sanded to provide a smooth surface for the sealers. Most of the gray primer coat is removed with the red primer acting as a depth signal for the sanding operation. The body is dried to remove all moisture.
4. SEALERS . . . One coat of sealer and one coat of color acrylic lacquer are applied and baked.
5. DRY SANDING . . . The body is dry sanded to prepare surfaces for the final acrylic lacquer.
6. LACQUERING . . . Three coats of acrylic lacquer are sprayed on the body to build up the required paint thickness. The paint is "rested" for eight minutes to permit it to partially set up and to remove excess volatile paint vehicle.
7. INITIAL BAKING . . . The body is oven baked for 30 minutes at 140 degrees F to harden the paint which permits the subsequent operation. Small interior and exterior parts are painted to complete the body paint schedule.
8. FINAL BAKING . . . To assure a durable, hard, high luster finish the lacquer is oven baked for 45 minutes at 250 degrees F. Reheating the lacquer permits the paint film to soften and allows surface blemishes and sanding scratches to disappear during the thermo-reflow process.
9. FINAL SANDING AND POLISHING . . . The body is lightly oil sanded and polished to bring painted surfaces to a high luster finish.

EXTERIOR-INTERIOR COLOR COMBINATIONS

			INTERIOR TRIM COLORS									
			Black	Red	Blue	Saddle	Silver	Green	White	White	White	Maroon
RPO number for vinyl trim			Reg. Prod.	407	414	420	426	430	437	443	450	435
RPO number for leather seat trim			402	408	415	421	427	431	438	444	451	436
EXTERIOR COLORS												
Sales Name	Color	RPO										
Tuxedo Black	Black	AA	X	X	X	X	X	X	X	X	X	X
Ermine White	White	CC	X	X	X	X	X	X	X	X	X	X
Nassau Blue	Med. Blue	FF	X		X						X	
Glen Green	Dark Green	GG	X			X		X	X			
Milano Maroon	Maroon	MM	X	X		X			X			X
Rally Red	Red	UU	X	X					X	X		
Goldwood Yellow	Yellow	XX	X						X			
Silver Pearl	Silver	OO	X	X			X					

Convertible top: Black, white or beige with any exterior color.
 Instrument panel black, carpet gray for silver 426,427 interiors.
 Instrument panel and carpet are black for white 437,438; red for 443,444; medium blue for 450,451.

BODY GLASS

BODY GLASS

Type ----- Solid safety plate
 except: windshield, laminated safety plate;
 soft top backlight, flexible plastic; hardtop
 backlight, Plexiglass.

Shape

Windshield ----- Single curved, 1 piece

Backlight

Soft top ----- Flat, 1 piece

Hardtop ----- Curved, 1 piece

Sport Coupe ----- Compound curved, 1 piece

Side door glass

Door glass ----- Compound curved

Ventipane ----- Compound curved

Area, sq. inches

Windshield ----- 789.7

Backlight

Soft top ----- 440.5

Hardtop ----- 888.2

Sport Coupe ----- 821.5

Side door glass

Door glass

Soft top and hardtop ----- 442.8

Sport Coupe ----- 528.3

Ventipanes

Soft top and hardtop ----- 107.3

Sport Coupe ----- 91.8

Total glass area

Soft top ----- 1780.3

Hardtop ----- 2228.0

Sport Coupe ----- 2231.3

BODY CONSTRUCTION

GENERAL

Construction ----- Uni-construction: fiber glass reinforced plastic body backboned by a steel cage outlining the passenger compartment. Principal members - underbody, front and rear end assemblies, dash panel, roof (Model 19437) and hinge pillars are bonded, riveted, or bolted together and to each other. Hood is plastic with bonded plastic reinforcement.

DOOR AND-LOCKS

Construction ----- Plastic, double paneled, reinforced with steel at hinge and lock locations. Front hinged.
Door handles ----- Push button with rotary type latches. Inside door locking knob on each door (upper reflector on side wall trim)
Door ventipanes operation ----- Crank

HOOD

Operation ----- Internal release lever. Front hinged with telescoping link on right side. Ratchet-type lock for hold open.

VENTILATION

Type ----- "Saddlebag" - cowl top air inlets channel air to cowl side kick panel outlets controlled by bowden cable operated valves. Water drainage at base of "saddlebag" plenum chambers.

SEATS

Type and construction ----- Bucket; leather grained vinyl covering over polyurethane padding

WINDSHIELD WIPERS

Type ----- Dual, two-speed, electric; washer provided
Linkage ----- Parallel acting

SPARE TIRE

Location ----- In well under fuel tank; accessible from underside of car. Cover with key lock provided.

TOOLS

Type ----- Scissors jack, and combination jack handle and lug wrench
Stowage ----- In well in luggage area directly behind drivers seat; carpeted cover over well.

CHASSIS

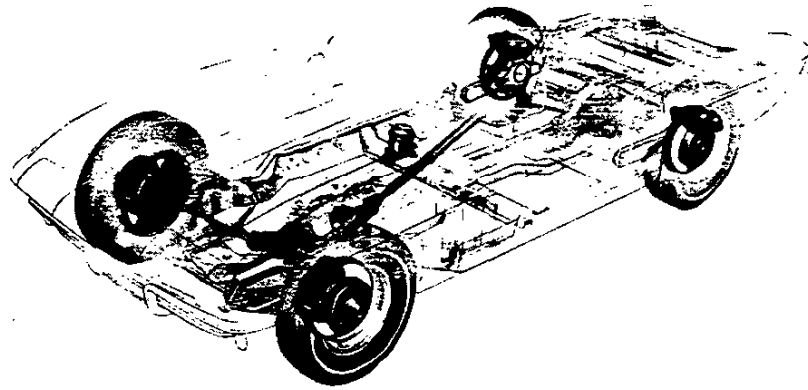

FRAME	2
FRONT SUSPENSION	2
STEERING	4
DRIVELINE	5
REAR SUSPENSION	5
REAR AXLE	6
BRAKES	8
WHEELS AND TIRES	9
BULBS, FUSES, AND CIRCUIT BREAKERS	9

FRAME

GENERAL

Description ----- All welded, full length, ladder constructed frame with 5 crossmembers. Side rails and intermediate crossmembers box section; front crossmember box girder section.

Dimensions

Width between

No. 4 body mounting holes ----- 49.32
 No. 3 body mounting holes ----- 55.14
 No. 1 body mounting holes ----- 55.14
 Front end mounting holes ----- 36.62

Length between

No. 4 body mounting holes and front end mounting holes ----- 130.82
 No. 3 body mounting holes and front end mounting holes ----- 93.32
 No. 1 body mounting holes and front end mounting holes ----- 41.92
 Height between (measured at top of holes exc. frt. end)
 No. 4 and No. 3 body mounting holes ----- 6.96
 No. 4 and No. 1 body mounting holes ----- 6.98
 No. 4 body and front end mounting holes ----- 7.90

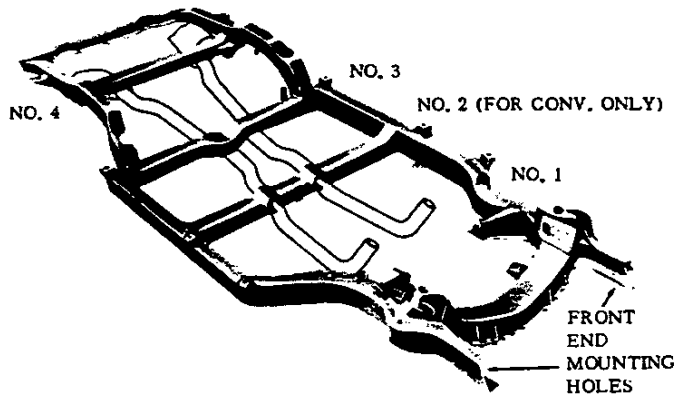

FRONT SUSPENSION

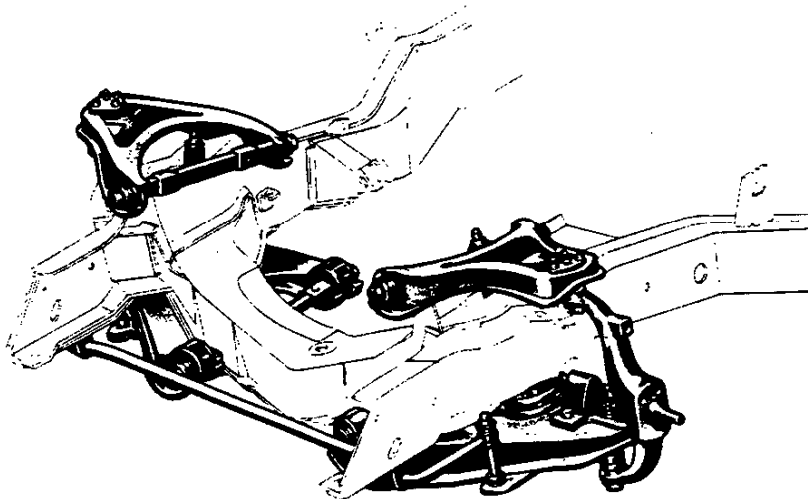

GENERAL

Description ----- Independent, SLA type with coil spring and concentric shock absorber, and spherically-joined steering knuckle, for each wheel. Adjustments to front suspension are achieved with shims at pivot shafts.

Wheel travel, from design height ----- 3.75

Jounce ----- 4.00

Rebound ----- 1.80

Wheel to spring ratio ----- 1.80

CONTROL ARMS

Description ----- Each is stamped

Upper and lower ----- A frame rubber-bushed at pivots.

Bushings

Type ----- Pre-loaded, steel encased rubber.

STEERING KNUCKLES

Description ----- Forged steel with detachable steering knuckle arm.

Spindle diameters

At inner bearing ----- 1.2493-1.2498

At outer bearing ----- .7492-.7497

Spindle thread size ----- 3/4-20 NEF-3 (modified)

FRONT SPRING

Part number ----- 3851100

Type ----- Right hand helix, variable rate

Material ----- AISI A-5160, heat treated

Cut-off length ----- 168.50

Number of coils (active, total) ----- 10.67, 12.00

Wire dia (theoretical) ----- .600

Outside dia, max. at ends (theoretical) ----- 5.19

Pitch dia (theoretical) ----- 4.40

Height

Free ----- 15.40

Working (inches @ lb) ----- 6.58 @ 1957,
8.56 @ 1340 (design load), 10.65 @ 932

Deflection rate (lb per inch) @ design load

@ Spring ----- 195

@ Wheel (wheel rate) ----- 80

FRONT WHEEL ALIGNMENT

Design

Camber (degrees) ----- 0 to P1

Caster (degrees) ----- P1-1/2 to P2-1/2

Toe-in, per wheel ----- 1/16

Curb

Camber (degrees) ----- P1/4 to P1-1/4

Caster (degrees) ----- P1 to P2

Toe, total ----- 7/32 to 11/32 toe in

Steering axis inclination (degrees) ----- 6-1/2 to 7-1/2

WHEEL BEARINGS

Type ----- Taper roller

Quantity ----- Two per spindle

SPHERICAL JOINTS

Type ----- Ball studs, upper self-adjusting for wear.

Bearing surfaces

Upper ----- Two surfaces, both non-metallic, the upper surface, a teflon-coated phenolic; the lower surface, a teflon-cotton composition

Lower ----- One upper surface, a teflon-cotton composition

Lubrication ----- High pressure grease fitting for each ball stud

SHOCK ABSORBERS

Type ----- Direct, double-acting, hydraulic; freon filled envelope in reservoir

Piston diameter ----- 1.00

STABILIZER BAR

Type ----- Link

Material ----- HR steel

Diameter ----- .750

Bushing material ----- Natural or synthetic rubber

STEERING

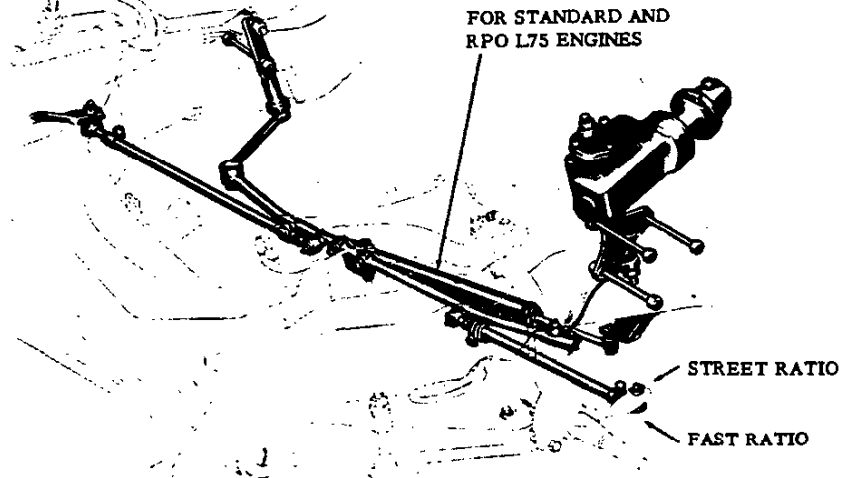

MANUAL STEERING, regular production

Description ----- Semi-reversible, recirculating ball nut steering gear with three-inch axial column adjustment; two-location steering arm-tie rod connection for street and fast ratio. Telescoping shaft steering available optionally.

System ratios
 Steering gear ----- 16:1
 Overall ratio
 Street ----- 20.2:1
 Fast ----- 17.6:1

Turning characteristics

Turning diameters (ft)
 Outside front, wall to wall ----- 41.6
 Outside front, curb to curb ----- 39.9
 Inside rear, wall to wall ----- 25.6
 Inside rear, curb to curb ----- 25.6

Number of wheel turns, lock to lock
 Street ----- 3.4
 Fast ----- 2.92

Outside wheel angle with inside wheel
 @ 15 degrees ----- 14.25
 @ 30 degrees ----- 25.43
 @ 34 degrees (limit of turn) ----- 27.37

Steering shaft
 Number ----- 1
 Diameter ----- .75

Steering wheel
 Type ----- Deep dished
 Diameter ----- 16.0
 Linkage
 Type ----- Parallelogram
 Location ----- Rear of wheels
 Number of tie rods ----- 2
 Lubrication points ----- 5; one at each tie rod; one at pitman arm-relay rod connection

POWER STEERING, RPO N40

(same as MANUAL STEERING except as follows)

Description ----- Hydraulic; pump powered cylinder assisting linkage

System ratios
 Steering gear ----- 16:1
 Overall ----- 17.6:1
 Number of wheel turns, lock to lock ----- 2.92

Outside wheel angle with inside wheel
 @ 15 degrees ----- 14.06
 @ 30 degrees ----- 25.17
 @ 34 degrees (limit of turn) ----- 27.20

Lubrication ----- Two additional fittings, at cylinder piston rod ball stud, and at valve adapter

BRAKES

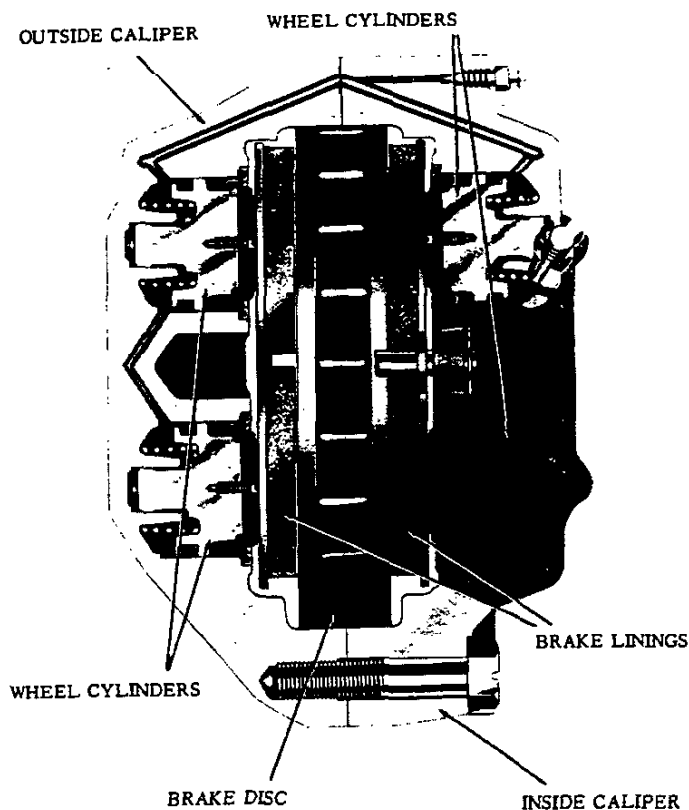

PARKING BRAKE

Type ----- Mechanical, internal
(separate from rear service brakes);
operates on rear wheels.

Control ----- T handle in passenger compartment

Drum diameter ----- 6.5

Brake lining

Number ----- 2 shoes per each rear wheel

Size (L x W x T) ----- 6.77 x 1.25 x .175

STOPLIGHT SWITCH

Type ----- Electrical; make-break, normally on

Location ----- On dash panel brace

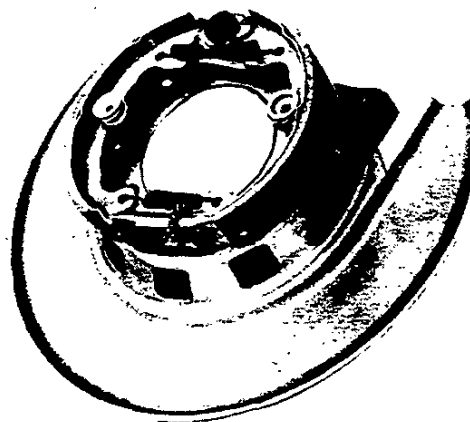

PARKING BRAKE

SERVICE BRAKES, Regular Production

General

Type ----- Caliper disc, 4-wheel hydraulic

Line pressure, psi, @ 100 lb pedal load ----- 550

Braking ratios

Pedal ----- 4.54

Hydraulic ----- 43.3

Overall ----- 196.6

Distribution of braking effort, front, percent ---- 65.0

Brake disc

Construction ----- Caliper type with radial
cavities for heat dissipation

Material ----- Cast iron

Diameter, front and rear ----- 11.75

Swept drum area, sq. inches ----- 461.2

Brake lining

Material ----- Woven asbestos

Size, all segments (L x W x T) ----- 5.96 x 2.21 x .41

Method of attachment ----- Bonded

Total effective area, sq. inches ----- 83.4

Gross lining area, sq. inches ----- 86.3

Master cylinder

Piston diameter ----- 1.00

Piston travel (with available pedal travel) ----- 1.10

Wheel cylinders

Number ----- 4 per wheel

Piston diameter

Front ----- 1.875

Rear ----- 1.375

Foot pedal travel ----- 5.00

POWER BRAKES, RPO J50 (Same as SERVICE BRAKES, Regular Production, except as follows)

General

Type ----- Vacuum power unit
added to assist master cylinder

Braking ratios

Pedal ----- 3.43

Hydraulic ----- 43.3

Overall ----- 148.5

Master cylinder

Type ----- Divided output

Piston travel (with foot pedal) ----- 1.20

Foot pedal travel ----- 4.12

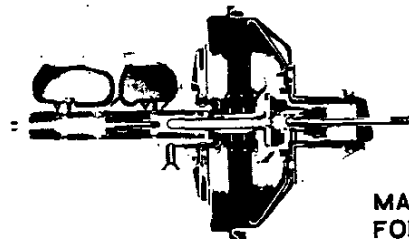

MASTER CYLINDER
FOR RPO J50

HYPOID AND PINION GEAR TOOTH COMBINATION

3.08 -----	37, 12
3.36 -----	37, 11
3.55 -----	32, 9
3.70 -----	37, 10
4.11 -----	37, 9
4.56 -----	41, 9

POSITRACTION DIFFERENTIAL (For availability, see POWER TRAINS)

Type ----- Two pinion with dual disc clutches

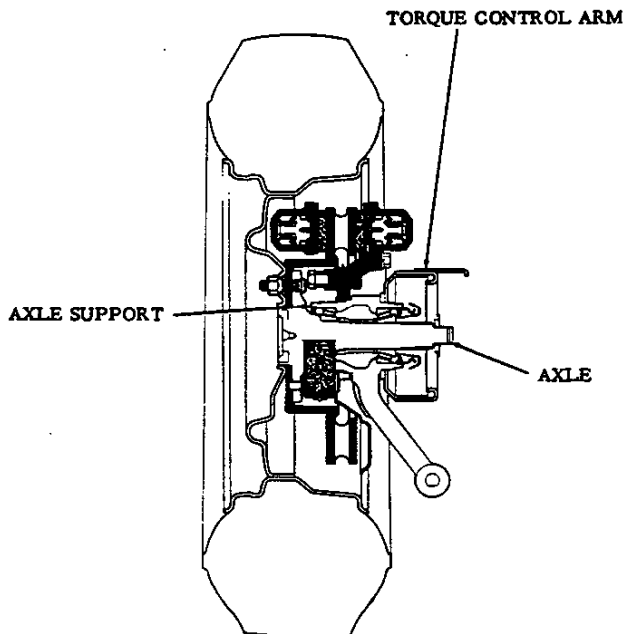

REAR WHEEL AND AXLE

GENERAL

Description ----- Brake disc flange integral with axle which is universally-jointed (thru splined axle flange) to axle shaft; torque control arm bolted to axle support. Axle supported by two taper roller bearings.

AXLE

Material ----- Steel forging, heat treated
 Diameter at outer bearing -----1.3743-1.3748
 Diameter at inner bearing -----1.1868-1.1873

AXLE SHAFT

Type ----- Welded steel tubing incorporating universal joint at each end

AXLE BEARINGS

Type -----Taper roller
 Quantity ----- 2 per wheel
 Bearing seals
 Description, outer and inner----Steel encased rubber

AXLE FLANGE

Material ----- Cast nodular iron

AXLE SUPPORT

Material ----- Cast nodular iron

TORQUE CONTROL ARM

Description ----- Welded steel box section

Headlamp hi-beam indicator	1-1445	1
Headlamp warning indicator	1-257	2
Heater	1-1893	2
Ignition switch	1-1445	1
Instrument cluster	7-1816	3
License plate rear	1-1155	4
Parking		
Park		4
Turn	2-1157	32
Parking brake alarm	1-257	2
Radio	1-1893	2
Spot lamp, portable	1-4416	30W
Tail		
Tail		4
Stop and turn	4-1157	32

CIRCUIT	TYPE OF PROTECTION	LOCATION AND CIRCUIT *
Air conditioning	AGC 30 fuse	In line
Air conditioning lamp	AGC 30 fuse	Fuse panel (f)
Backup lamps	AGC 4 fuse	Fuse panel (d)
Cigarette lighter	AGC 10 fuse	Fuse panel (b)
Cigarette lighter lamp	AGC 15 fuse	Fuse panel (c)
Clock	AGC 4 fuse	Fuse panel (d)
Clock lamps	AGC 15 fuse	Fuse panel (c)
Courtesy lamps	AGC 15 fuse	Fuse panel (c)
Dome lamp	AGC 15 fuse	Fuse panel (c)
Fuel gage	AGC 10 fuse	Fuse panel (g)
Glove compartment lamp	AGC 15 fuse	Fuse panel (c)
Headlamp hi-beam indicator lamp	15 amp CB	Light switch
Headlamp motors	50 amp CB	Hinge pillar
Headlamp warning indicator lamp	40 amp CB	Hinge pillar
Headlamps	15 amp CB	Light switch
Heater	AGC 10 fuse	Fuse panel (f)
Heater lamp	AGC 4 fuse	Fuse panel (d)
Ignition switch lamp	AGC 4 fuse	Fuse panel (d)
Instrument cluster lamps	AGC 4 fuse	Fuse panel (d)
License plate, rear	AGC 10 fuse	Fuse panel (b)
Parking brake alarm lamp	AGC 10 fuse	Fuse panel (g)
Parking lamps	15 amp CB	Light switch
Power windows	40 amp CB	Hinge pillar
Radio and radio lamp	AGC 2.5 fuse	Fuse panel (e)
Radio antenna	AGC 15 fuse	Fuse panel (c)
Rear compartment vent motor	AGC 10 fuse	Fuse panel (f)
Stop lamps	AGC 15 fuse	Fuse panel (c)
Tail lamps	AGC 10 fuse	Fuse panel (b)
Temperature gage	AGC 10 fuse	Fuse panel (g)
Windshield wiper	14 amp CB	Switch
Spot lamp, portable	AGC 15 fuse	Fuse panel (c)

* Letter suffix indicates same circuit.

WHEELS AND TIRES

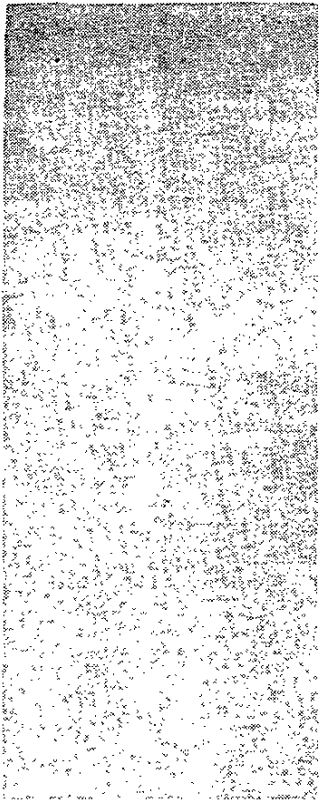

WHEELS, Regular Production

Type ----- Short spoke spider
 Attachment to hub ----- 5 hex nuts, 7/16-20 UNF-2B,
 arranged on a 4.75 diameter bolt circle
 Offset ----- .44
 Rim size ----- 15 x 5.5K

WHEEL, RPO 2-P48

Type ----- Quick take-off
 Material ----- Cast aluminum
 Rim size ----- 15 x 6L
 Offset ----- .61
 Method of retension ----- Adapter
 and lock nut (2-5/8 - 8 UN 2B)

● TIRES, Regular Production

Type ----- Rayon tubeless, blackwall
 Construction ----- 4 ply
 Size and ply rating ----- 7.75 x 15-4 PR
 Specifications
 Loaded rolling radius ----- 12.6
 Loaded rev/mi @ 50 MPH ----- 776
 Capacity (lb @ psi) ----- 1100 @ 24
 Recommend inflation, all tires, psi ----- 24

SPARE TIRE

Location ----- Under gasoline tank, accessible
 from underside of vehicle, shielded with cover.

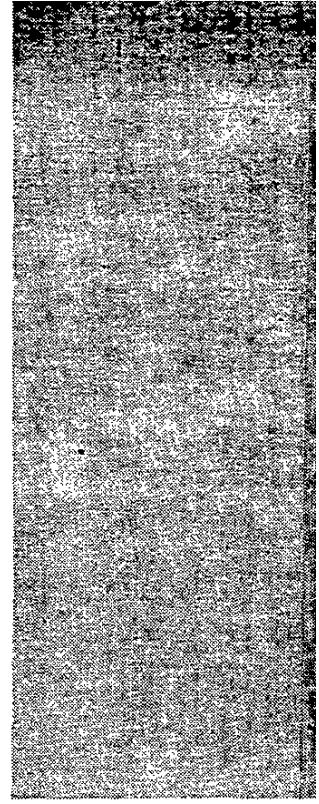

BULBS, FUSES, AND CIRCUIT BREAKERS

LAMPS	NO. REQUIRED AND TRADE NO.	CANDLE POWER PER LAMP
Air conditioning	1-1893	2
Back up	2-1156	32
Cigarette lighter	1-1445	1
Clock	2-1816	3
Courtesy		
Instrument panel	2-90	6
Rear compartment	1-90	6
Direction signal indicator	2-1816	3
Dome	1-90	6
Glove compartment	1-1893	2
Headlamp	Outer	2-4002
		High beam, 37.5W
		Low beam, 55.0W
Inner	2-4001	High beam, 37.5W

BULBS, FUSES AND CIRCUIT
 BREAKERS CONTINUED ON
 PAGE 10

POWER TRAINS

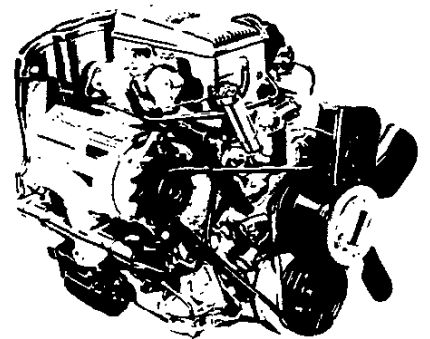
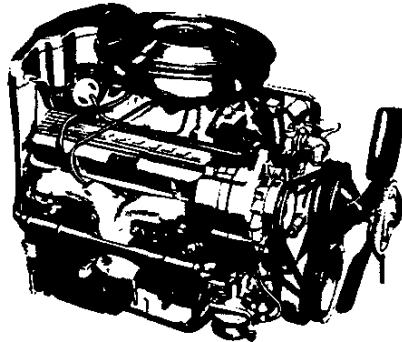

POWER TEAM COMBINATIONS	2
ENGINE DATA AND RATINGS	3
ENGINE SPEED AND PISTON TRAVEL	3
VEHICLE PERFORMANCE FACTORS	4
ENGINE OUTPUT CURVES	5
PRINCIPAL COMPONENTS	7
FUEL SYSTEM	11
EXHAUST AND VENTILATION SYSTEM	12
LUBRICATION SYSTEM	12
COOLING SYSTEM	13
ELECTRICAL SYSTEM	13
CLUTCHES	15
THREE AND FOUR SPEED TRANSMISSIONS	15
POWERGLIDE	16

POWER TEAM COMBINATIONS

AXLE RATIOS**

ENGINE	EQUIPMENT	TRANSMISSION	General Purpose Standard	Special Purpose or Mountain	Performance Cruise	High Performance
250 HP ENGINE 327 CUBIC INCH V-8 STANDARD	FOUR-BARREL CARBURETOR HYDRAULIC LIFTERS	3-SPEED (2.58:1 low) 4-SPEED (2.56:1 low) POWERGLIDE	3.36:1			
			3.36:1		3.08:1	
			3.36:1			
300 HP ENGINE 327 CUBIC INCH V-8 RPO - L75	LARGE 4-BARREL ALUMINUM CARB. HYDRAULIC LIFTERS	4-SPEED (2.56:1 low) POWERGLIDE	3.36:1		3.08:1	
			3.36:1			
350 HP ENGINE 327 CUBIC INCH V-8 RPO - L79	LARGE 4-BBL CARB. HIGH LIFT CAM HYDRAULIC FILTERS	4-SPEED (2.20:1)	3.70:1	4.11:1*	3.55:1	
365 HP ENGINE 327 CUBIC INCH V-8 RPO - L76	LARGE 4-BBL CARB. SPECIAL CAMSHAFT MECHANICAL LIFTERS	4-SPEED (2.20:1 low)	3.70:1	4.11:1*	3.08:1*	4.56:1*
					3.36:1*	
					3.55:1*	
375 HP ENGINE 327 CUBIC INCH V-8 RPO - L84	FUEL INJECTION SPECIAL CAMSHAFT MECHANICAL LIFTERS	4-SPEED (2.20:1 low)	3.70:1	4.11:1*	3.08:1*	4.56:1*
					3.36:1*	
					3.55:1*	
425 HP ENGINE 396 CUBIC INCH V-8 RPO - L78	LARGE 4-BBL CARB. SPECIAL CAMSHAFT MECHANICAL LIFTERS	4-SPEED (2.20:1 low)	3.36:1*	4.11:1*	3.08:1*	4.56:1*
					3.55:1*	3.70:1*

* - AVAILABLE AS POSITRACTION AXLE ONLY.

** - POSITRACTION AXLE RATIOS AVAILABLE IN COMBINATIONS SHOWN.

MULTIPLICATION FACTORS

with MANUAL TRANSMISSIONS

ENGINE	CARBURETION	TRANSMISSION	TOTAL GEAR REDUCTION*					AXLE RATIO	MAX. AXLE TORQUE LOW# GEAR (LB-FT)
			1st	2nd	3rd	4th	Rev		
250 HP Standard	4-Barrel	3-Speed (2.58:1)	8.67	4.97	3.36		8.67	3.36:1	2321
		4-Speed (2.56:1)	8.60	6.42	4.97	3.36	8.87		2304
300 HP RPO - L75	Large 4-Barrel Aluminum	4-Speed (2.56:1)	8.60	6.42	4.97	3.36	8.87	3.36:1	
350 HP RPO - L79	Large 4-Barrel	4-Speed (2.20:1)	8.14	6.07	4.74	3.70	8.40	3.70:1	
365 HP RPO - L76	Large 4-Barrel	4-Speed (2.20:1)	8.14	6.07	4.74	3.70	8.40	3.70:1	
375 HP RPO - L84	Fuel Injection	4-Speed (2.20:1)	8.14	6.07	4.74	3.70	8.40	3.70:1	
425 HP RPO - L78	Large 4-Barrel	4-Speed (2.20:1)	7.39	5.51	4.30	3.36	7.63	3.36:1	

with AUTOMATIC TRANSMISSIONS

ENGINE	TRANSMISSION	SELECTOR POSITION	TOTAL TORQUE MULTIPLICATION*	AXLE RATIO
250 HP - Standard 300 HP - RPO-L75	Powerglide	Drive Low & Reverse	12.43:1 - 3.36:1 12.43:1 - 5.91:1	3.36:1

* - Axle ratio x transmission ratio.

- Gear reduction x maximum net torque x efficiency factor (0.90 in drive, 0.85 all others).

ENGINE DATA AND RATING

GENERAL DATA

Engine Type		V-8 OHV				
Piston Displacement (Cu. In.)		327			396	
Availability	Std.	RPO-L75	RPO-L79	RPO-L76	RPO-L84	RPO-L78
Number Cylinders		Eight				
Bore and Stroke (nominal)		4.00 x 3.26				4.09 x 3.76
Compression Ratio		10.5:1				11.0:1
Taxable (SAE) Horsepower		51.2				53.6
Firing Order		1 - 8 - 4 - 3 - 6 - 5 - 7 - 2				
Idling Speed (RPM)		500				700
Compression Press. (PSI) @ Cranking Speed, Engine Hot		160				
Lubrication		Full pressure				
Power Plant Mounting		Two front, compression type; one rear, compression type				
Measurements	Fan to rear of engine block	30.52				32.31
	Top air cleaner to bottom oil pan	27.28	26.48	26.48	27.25	28.33
	Exhaust manifold to generator (width)	28.54				31.34

ADVERTISED ENGINE RATINGS

Engine	250 HP	300 HP	350 HP	365 HP	375 HP	425 HP
Availability	Standard	RPO-L75	RPO-L79	RPO-L76	RPO-L84	RPO-L78
Brake HP	Gross 250 @ 4400 Net 210 @ 4400	300 @ 5000	350 @ 5800	365 @ 6200	375 @ 6200	425 @ 6400
Torque (lb-ft)	Gross 350 @ 2800 Net 315 @ 2600	360 @ 3200	360 @ 3800	350 @ 4000	350 @ 44-4800	415 @ 4000

ENGINE SPEED AND PISTON TRAVEL

Transmission	3-Speed (a)	4-Speed			Powerglide (b)	
		2.56 low	2.20 low			
Rear Axle Ratio	3.36:1	3.36:1 (c)	3.36:1 (e)	3.70:1 (d)	3.36:1	
Tire Size		7.75 x 15 - 4PR				
Crankshaft Revolutions per Mile		2553.6			2812.0	2553.6
Crankshaft RPM @ 1 MPH	Low	109.8	108.9	93.6	103.1	74.9
	Second	63.0	61.3	69.8	76.9	
	Third	42.6	63.0	54.5	60.0	
	Fourth		42.6	42.6	46.9	42.6 (direct)
	Reverse	109.8	112.3	96.6	106.4	74.9
Piston Travel (Ft/Mile)		1383.2			1523.1	1383.2

- (a) Available only with 250 HP engine.
 (b) Available only with 250 and 300 HP engines.
 (c) Standard ratio for 250 and 300 HP; optional for 350, 365 and 375 engines.
 (d) Standard ratio for 350, 365 and 375 HP engines.
 (e) Standard ratio for 425 HP engine.

VEHICLE PERFORMANCE FACTORS

ENGINE	327 Cu. In. 250 HP Standard	327 Cu. In. 300 HP RPO L75	327 Cu. In. 350 HP RPO L79	327 Cu. In. 365 HP RPO L76	327 Cu. In. 375 HP RPO L84	396 Cu. In. 425 HP RPO L78
--------	-----------------------------------	----------------------------------	----------------------------------	----------------------------------	----------------------------------	----------------------------------

3-SPEED TRANSMISSION

Performance Weight (pounds)	3439	3440	3436			
Pounds per Gross Horsepower	13.76	11.47	9.82			
Pounds per Cu.In. Displacement	10.52	10.52	10.51			
Gross HP per Cu.In. Displacement	.765	.917	1.070			
Power Displacement (cu.ft./mile)	241.62	241.62	266.07			
Displacement Factor (cu.ft./ton mile)	140.52	140.47	154.87			

4-SPEED TRANSMISSION

Performance Weight (pounds)	3441	3442	3438	3431	3448	3706
Pounds per Gross Horsepower	13.76	11.47	9.82	9.40	9.19	8.72
Pounds per Cu.In. Displacement	10.52	10.53	10.51	10.49	10.54	9.36
Gross HP per Cu.In. Displacement	.765	.917	1.070	1.162	1.15	1.07
Power Displacement (cu.ft./mile)	241.62	241.62	266.07	266.07	266.07	301.32
Displacement Factor (cu.ft./ton mile)	140.43	140.39	154.78	155.14	154.33	162.61

POWERGLIDE*

Performance Weight (pounds)	3462	3463				
Pounds per Gross Horsepower	13.85	11.54				
Pounds per Cu.In. Displacement	10.59	10.59				
Gross HP per Cu.In. Displacement	.765	.917				
Power Displacement (cu.ft./mile)	241.62	241.62				
Displacement Factor (cu.ft./ton mile)	139.58	139.58				

* - Data computed assuming zero slippage in torque converter.

GLOSSARY

Performance Weight	Curb Weight plus 300 Lb (weight of two 150 lb passengers)
Power Displacement	$\frac{\text{Crankshaft Revs/Mi} \times \text{Piston Displacement}}{2 \times 1728}$
Displacement Factor	$\frac{\text{Power Displacement}}{\text{Performance Wt. (tons)}}$

ENGINE OUTPUT CURVES

250 HP TURBO-FIRE V-8

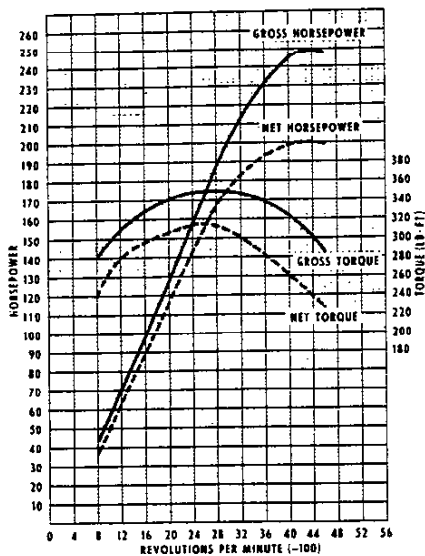

300 HP TURBO-FIRE V-8

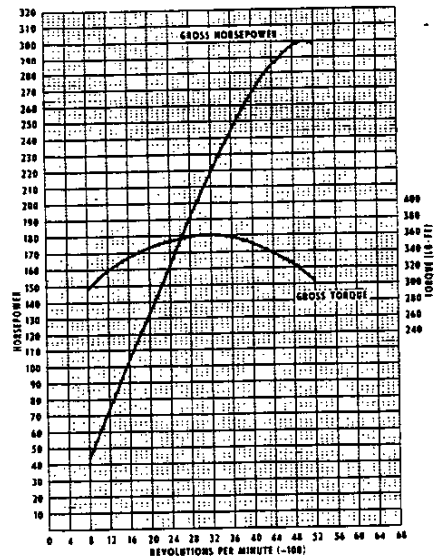

350 HP TURBO-FIRE V-8

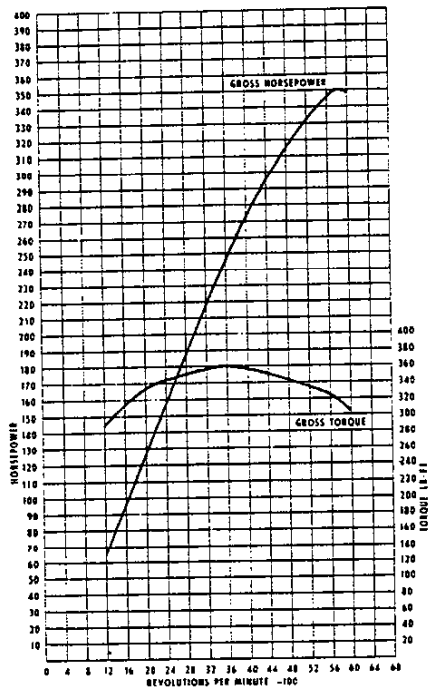

● 425 HP TURBO-JET V-8

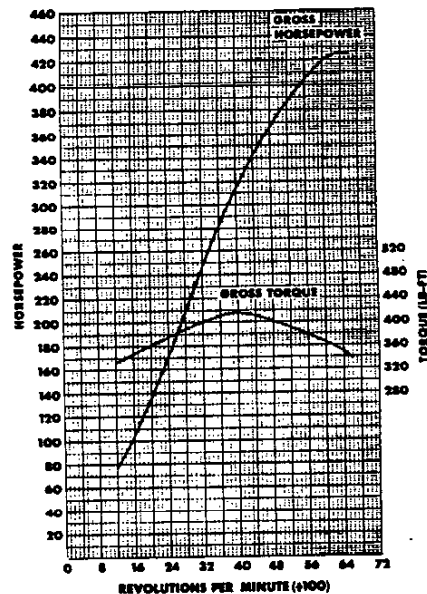

The engine output curves represent full throttle performance as obtained from dynamometer test data corrected to standard barometric pressure 29.92 inches of mercury and standard temperature of 60 degrees F.

GROSS POWER and TORQUE were obtained in a regular dynamometer test with the dynamometer exhaust system,

no fan, generator not charging, optimum spark advance, and optimum fuel setting.

NET POWER and TORQUE were obtained from a dynamometer test simulating actual operating conditions when the engine is in its vehicle, except the generator is not charging.

ENGINE OUTPUT CURVES

365 HP TURBO-FIRE V-8

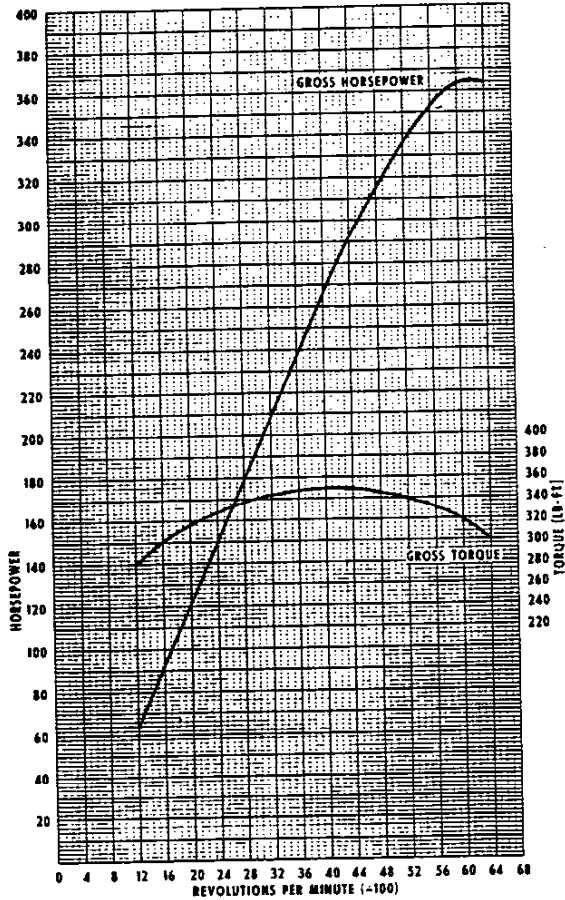

375 HP FUEL INJECTION V-8

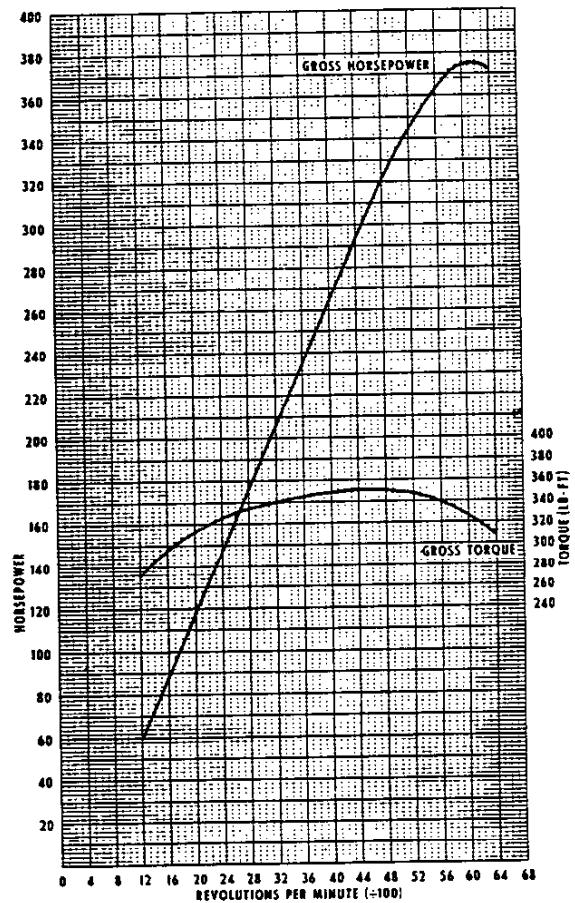

The engine output curves represent full throttle performance as obtained from dynamometer test data corrected to standard barometric pressure 29.92 inches of mercury and standard temperature of 60 degrees F.

GROSS POWER and TORQUE were obtained in a regular dynamometer test with the dynamometer exhaust system,

no fan, generator not charging, optimum spark advance, and optimum fuel setting.

NET POWER and TORQUE were obtained from a dynamometer test simulating actual operating conditions when the engine is in its vehicle, except the generator is not charging.

PRINCIPAL COMPONENTS

CYLINDER BLOCK

Material	Cast alloy iron
Bore diameter	3.9995-4.0025
	V8-396 4.0925-4.0955
Bore spacing (centerline to centerline)	4.4
	V8-396 4.84
Number of bulkheads	5
Water jackets	Full length around each cylinder
Cylinder numbering arrangement (front to rear)	
Left bank	1-3-5-7
Right bank	2-4-6-8

CYLINDER HEAD

Material	High chrome cast alloy iron
Bolt no. & size	34; 36 (396 Cu. In.) .4375 dia. 14 threads/incl.

COMBUSTION CHAMBER VOLUME

(Total chamber volume of assembled engine with piston at top center)	
250 HP & 300 HP engines	4.49 cu.in.
350 HP, 365 HP & 375 HP engines	3.97 cu.in.
425 HP (396 Cu. In.)	4.95 cu.in.

INLET MANIFOLD

Material	
250 HP & 300 HP engines	Cast alloy iron
350, 365, & 425 HP engines	Cast aluminum alloy
Heat provision	
250, 300, 350, 365 & 425 HP	Exhaust gas cross-over at carburetor mtg. pad
375 HP engine	None

EXHAUST MANIFOLD

Material	Cast alloy iron
Type	Dual, 4 port, center downtake
Outlet diameter (nominal)	
250 HP (all trans.) & 300 HP (P/Glide)	2.00
300, 350, 365 & 375 HP (3 & 4 speed)	2.50
425 HP (396 Cu. In.)	2.50

CRANKSHAFT

Material	Forged steel
End play	.002-.006
Counterweights	6
Crank arm length	1.625
	396 Cu. In. 1.88
Vibration damper	Rubber mounted inertia
Timing gear	Steel; sprocket & chain
Pulley pitch diameter	6.64

MAIN BEARINGS

Material	Premium aluminum except No. 5 sintered copper nickel backed babbit
Type	Precision removable
Thrust against bearing no.	5
Clearance	(#1-4) .0008-.0034; (#5) .0010-.0036
	396 cu.in. (#1-4) .0004-.0028; (#5) .0017-.0033

Dimensions

	Theoretical	Effective	Projected
Inner Dia.	Length	Area	

V8-327 Cu. In.

Bearing #1			
250 & 300 HP	2.3013	.752	1.7306
300, 365 & 375 HP	2.3009	.752	1.7303
Bearing #2-4	2.3009	.752	1.7303
Bearing #5	2.3006	1.1824	2.7202

V8-396 Cu. In.

Bearing #1-4	2.7508	.992	2.7288
Bearing #5	2.7512	1.2525	3.4446

CRANKSHAFTS AND BEARINGS

327 CUBIC INCH V-8 ENGINE

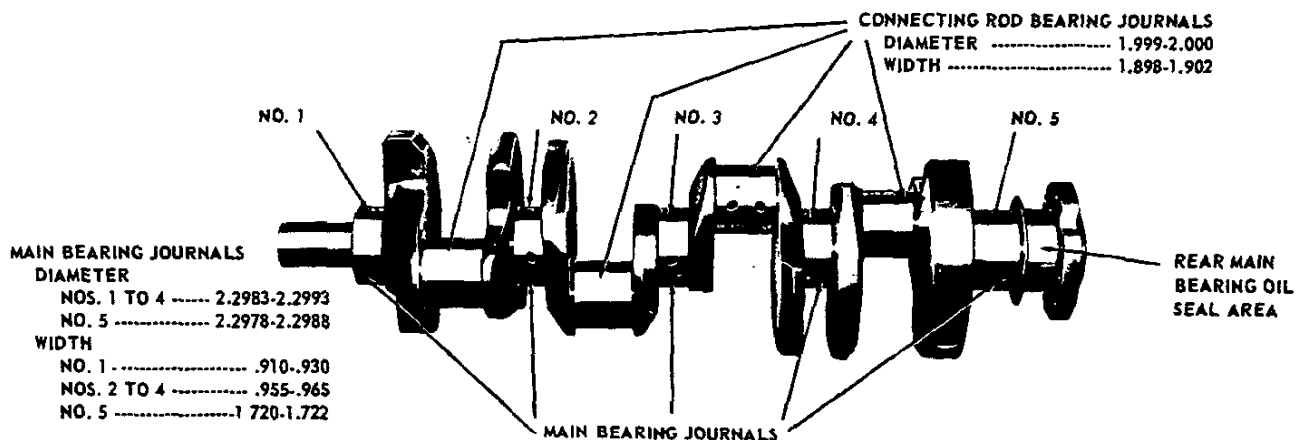

PRINCIPAL COMPONENTS—Cont'd.

CAMSHAFT

Material	Cast alloy iron
Drive	Sprocket & chain; steel
Lobe Lift	
250 HP & 300HP Engines	.2658 Inlet & Exhaust
350 HP Engine	.2981 Inlet & Exhaust
365 HP & 375 HP Engines	.3234 Inlet & Exhaust
Bearings	5; steel backed babbit
425 HP (396 Cu. In.)	.3057 Inlet & Exhaust

VALVE TRAIN

Type	Individually mounted overhead rocker arms, push rod actuated
Lifters	
250 HP, 300 HP & 350 HP Engines	Hydraulic
365 HP, 375 HP & 425 HP Engines	Mechanical
Push Rods	
Type	Hollow steel
Ends	
250 HP, 300HP & 350 HP Engines	Hardened
365 & 375 HP Engines	Hardened steel inserts
425 HP (396 Cu. In.)	Carburized steel inserts
Rocker Arms	
Material	Stamped steel
Ratio	1.5:1
	396 Cu. In. 1.7:1

VALVE TRAIN LASH

Inlet & Exhaust	
250 HP, 300 HP & 350 HP Engines	Zero
365 HP & 375 HP Engines	.025
425 HP (396 Cu. In.)	.020

VALVE SPRINGS

Diameter (I.D.)	.872-.888
	V8 396 1.082-1.098
Installed Length (in. @ lb)	
Valves Closed	1.66 @ 78-86
	V8 396 1.88 @ 94-106
Valves Opened	1.26 @ 170-180
	V8 396 1.38 @ 303-327
Free Length	2.08
	V8 396 2.09
Valve Spring Damper	Steel, 4 coils
Oil Shield	Steel cup

VALVE TIMING (Crankshaft Degrees)

250 HP & 300 HP Engines	Excluding Ramps	Including Ramps
Inlet Valve		
Opens-BTC	12° 30'	32° 30'
Closes-ABC	57° 30'	87° 30'
Duration	250°	300°
Exhaust Valve		
Opens-BBC	54° 30'	74° 30'
Closes-ATC	15° 30'	45° 30'
Duration	250°	300°

350 HP Engine	Excluding Ramps	Including Ramps
Inlet Valve		
Opens-BTC	40°	54°
Closes-ABC	86°	108°
Duration	306°	342°
Exhaust Valve		
Opens-BBC	88°	102°
Closes-ATC	38°	60°
Duration	306°	342°

365 HP & 375 HP Engines	Including Ramps
Inlet Valve opens with .025 lash	
Opens-BTC	60° 50'
Closes-ABC	105° 23'
Duration	346° 13'
Exhaust Valve closes with .025 lash	
Opens-BBC	108° 50'
Closes-ATC	57° 23'
Duration	346° 13'

425 HP (396 Cu. In.) Engine	Including Ramps
Inlet Valve opens with .020 lash	
Opens-BTC	54°
Closes-ABC	102°
Duration	336°
Exhaust Valve closes with .020 lash	
Opens-BBC	102°
Closes-ATC	54°
Duration	336°

VALVE LIFT

Inlet & Exhaust	
250 HP & 300HP Engines	.3987
350 HP Engine	.4472
365 HP & 375 HP Engines	.4851
425 HP (396 Cu. In.)	.5197

CAMSHAFT AND BEARINGS

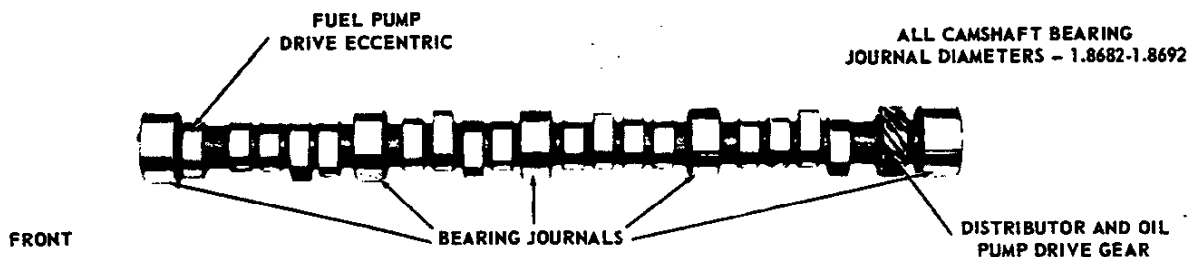

VALVES - INLET

Material	Alloy steel
Coating	
V8 - 327 Cu. In.	None
V8 - 396 Cu. In.	Face & head aluminized; chrome flash stem on RPO L78

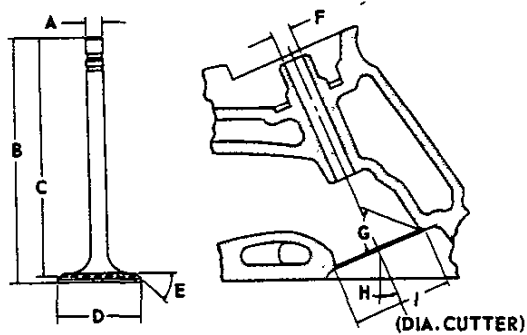

A - Stem Diameter	
V8-327	.3404-.3417
V8-396	.3715-.3722
B - Overall Length	
V8-327	4.870-4.889
V8-396	5.204-5.224
C - Gage Length	
V8-327	4.785-4.795
V8-396	5.115-5.125
D - Overall Head Diameter	
V8-327 (250 & 300 HP)	1.935-1.945
V8-396 (350, 365 & 375 HP)	2.017-2.023
V8-396	2.185-2.195
E - Angle of Face	45°
F - Guide Diameter	
V8-327	.3427-.3437
V8-396	.3732-.3742
G - Angle of Seat	46°
H - Valve Angle	
V8-327 (250 & 300 HP)	23°
V8-327 (350, 365 & 375 HP)	25°
V8-396	4°
I - Valve Seat (Cutter) Diameter	
V8-327 (250 & 300 HP)	1.990-2.010
V8-327 (350, 365 & 375 HP)	2.020
V8-396	2.580

VALVES - EXHAUST

Material	High alloy steel
Coating	
V8 - 327 (250 & 300 HP)	Aluminum face
350, 365, 375 & 425 HP	Face & head aluminized; chrome flash stem on 396 Cu. In.

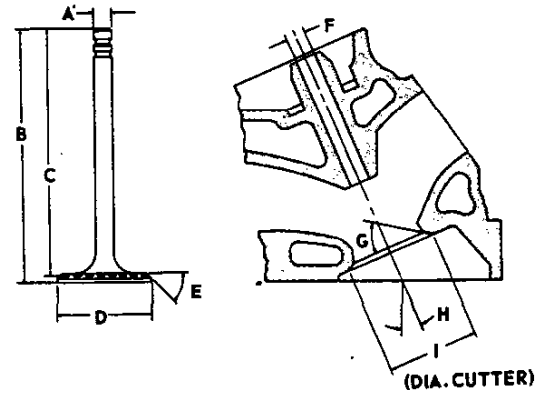

A - Stem Diameter	
V8-327	.3410-.3417*
V8-396	.3713-.3720
B - Overall Length	
V8-327 (250 & 300 HP)	4.913-4.933
V8-327 (350, 365 & 375 HP)	4.891-4.910
V8-396	5.345-5.365
C - Gage Length	
V8-327	4.781-4.791
V8-396	5.235-5.245
D - Overall Head Diameter	
V8-327 (250 & 300 HP)	1.495-1.505
V8-327 (350, 365 & 375 HP)	1.595-1.605
V8-396	1.715-1.725
E - Angle of Face	45°
F - Guide Diameter	
V8-327	.3427-.3437
V8-396	.3732-.3742
G - Angle of Seat	46°
H - Valve Angle	
V8-327 (250 & 300 HP)	23°
V8-327 (350, 365 & 375 HP)	25°
V8-396	4°
I - Valve Seat (Cutter) Diameter	
V8-327 (250 & 300 HP)	1.550-1.570
V8-327 (350, 365 & 375 HP)	1.610
V8-396	2.120

PRINCIPAL COMPONENTS—Cont'd.

PISTONS

Material	
250 & 300 HP engines	Cast aluminum alloy
350, 365, 375 & 425 HP engines	Aluminum impact extruded
Head type	
250 & 300 HP engines	Flat, notched
350, 365, 375 & 425 HP engines	Domed
Skirt type	
	Slipper
Top land clearance	
250 & 300 HP engines	.0365-.0455
350, 365 & 375 HP engines	.0395-.0425
425 HP (396 Cu. In.)	.0265-.0335
Skirt clearance	
250 & 300 HP engines	.0005-.0011
350, 365 & 375 HP engines	.0039-.0045
425 HP (396 Cu. In.)	.0027-.0033
Compression ring groove depth	
	.2217-.2283
V8-396 Cu. In.	.2253-.2218
Oil ring groove depth	
	.2038-.2103
V8-396 Cu. In.	.2118-.2128
Pin bore offset	
250 & 300 HP engines	.055-.065
350, 365, 375 & 425 HP engines	On center
Compression height	
250 & 300 HP engines	1.674-1.676
350, 365 & 375 HP engines	1.673-1.677
425 HP (396 Cu. In.)	2.125-2.129

COMPRESSION RING - UPPER

Material	
	Cast alloy iron
Type	
	Inside bevel (bottom of ring 30 degrees to piston vertical axis)
Face	
	Tapered
Coating	
250 & 300 HP engines	Chrome plate
350, 365, 375 & 425 HP engines	Molybdenum
Width	
	.0775-.0780
V8-396 Cu. In.	.0620-.0625
Wall thickness	
	.190-.200
Gap	
250 & 300 HP engines	.013-.023
350, 365 & 375 HP engines	.013-.025
425 HP (396 Cu. In.)	.010-.020

COMPRESSION RING - LOWER

Type	
250 & 300 HP engines	One ring and one expander
350, 365, 375 & 425 HP engines	One ring
Material	
	Cast alloy iron
Inside bevel	
	Top edge 30 degrees to piston vertical axis
Face	
	Tapered

Coating	
250 & 300 HP engine	Wear resistant
350, 365, & 425 HP engines	Molybdenum
Width	
	.0770-.0775
V8-396 Cu. In.	.0620-.0625
Wall thickness	
250 & 300 HP engines	.164-.170
350, 365, 375 & 425 HP engines	.190-.200
Gap	
	.013-.025
Expander (250 & 300 HP engines only)	
Material	
	Steel
Width	
	.068-.074
Wall thickness	
	.02075

OIL CONTROL RINGS

Type	
	Multi-piece (two rails and one spacer)
Material	
Rails	Steel
Spacer	Alloy steel
Width	
	.1840-.1880
V8-396 Cu. In.	.1890-.1910
Wall thickness	
	.150-.156
Gap	
	.015-.055
V8-396 Cu. In.	.010-.030
Rail coatings	
	Chrome plated

PISTON PINS

Material	
	Chromium steel
Length	
	2.990-3.010
V8-396 Cu. In.	2.930-2.950
Diameter	
	.9270-.9273
V8-396 Cu. In.	.9895-.9898
Clearance in piston	
250 & 300 HP engines	.00015-.00025
350, 365 & 375 HP engines	.00045-.00055
425 HP (396 Cu. In.)	.00025-.00035
Pin mounting	
	Locked in rod by shrink fit

CONNECTING RODS

Material	
	Drop forged steel
Length (center to center)	
	5.699-5.701
V8-396 Cu. In.	6.134-6.136

CONNECTING ROD BEARINGS

Material	
	Premium aluminum
Type	
	Precision removable
Clearance	
	.0007-.0028
V8-396 Cu. In.	.0014-.0030
Theoretical I.D.	
	2.0017
V8-396 Cu. In.	2.2012
Effective length	
	.807
V8-396 Cu. In.	.857
End play	
	.009-.013
V8-396 Cu. In.	.016-.020

FUEL SYSTEM

FUEL TANK

Capacity (Gal) ----- 20
Location ----- In body cavity at rear of deck area
Filler Location ----- Center of rear deck lid

FUEL FILTERS, DUAL

In Fuel Tank ----- Mesh strainer
250 HP Engine ----- Sintered bronze filter
in carburetor inlet
300 HP, 350 HP & 365 HP ----- In-line can with paper
element between carb. and fuel pump
375 & 425 HP Engines --- In-line can with paper element
between fuel pump and fuel meter assembly

FUEL PUMP

Type ----- Diaphragm
Drive ----- Camshaft eccentric
Location ----- Lower right front of engine
Pressure Range
250, 300 & 425 HP Engines ----- 5.25-6.50 PSI
350 HP, 365 HP & 375 HP Engines ----- 6.00-7.50 PSI

AIR CLEANER

250 & 300 HP Engines ----- Cylindrical; dual air horns
350, 365 & 425 HP Engines --- Cylindrical, louver inlet
chrome-plated cannister
375 HP Engine ----- Conical, located in
air intake ducting
Filter Element ----- Oil-wetted polyurethane

CARBURETORS

Make & Type
250 HP, & 300 HP ----- Carter; 4-bbl. downdraft
350, 365 & 425 HP ----- Holley; 4-bbl. downdraft
SAE Flange Size ----- 1.50
Throttle Bore
250HP ----- 1.4375 Primary & Secondary
300HP ----- 1.5625 Primary; 1.6875 Secondary
350HP & 365 HP ----- 1.561 Primary & Secondary
425 HP (396 Cu. In.) --- 1.686 Primary & Secondary
Venturi Diameter
250 HP ----- 1.06 Primary; 1.25 Secondary
300HP ----- 1.25 Primary; 1.56 Secondary
350 HP & 365 HP ---- 1.25 Primary; 1.3125 Secondary
425 HP (396 Cu. In.) - 1.375 Primary; 1.4375 Secondary
Secondary Throttle Actuation ----- By linkage
approximately when primary valves are
opened half between closed and open

CHOKE

Type ----- Automatic

FUEL INJECTION (375 HP Engine)

GENERAL

Make ----- Rochester Products
Model ----- 7017380
Type --- Mass air flow with continuous fuel injection

AIR INDUCTION

Description ----- Outside air ducted
thru air cleaner to air meter
Outside Air Ducting
Location ----- Left side of engine compartment
Air Cleaner
Type -- Oil-wetted, polyurethane element; conical
Air Meter
Flow Control ----- Throttle valve
Flow Measurement ----- Annular venturi
Cold Enrichment
Type ----- Choke
Action ----- Automatic, bi-metallic
spring and exhaust heat

FUEL METER

Flow Control ----- Continuous flow pump with
diaphragm controlled bypass; system
feeds measured amounts of fuel directly
to intake ports where orifice injection
nozzles direct fuel to intake valves.

Pump

Type ----- Gear
Drive ----- Flexible shaft from distributor
Output PSI, Maximum ----- 200
Bypass System
Control ----- Diaphragm controlled spill
valve - by vacuum from air
meter annular venturi

Injection Nozzles

Quantity ----- 8
Type ----- Continuous flow
Material ----- Brass
Location --- On intake manifold above intake ports
Orifice diameter ----- .0118
Insulation ----- Bakelite block

DISTRIBUTION SYSTEM

Intake Manifold
Type ----- Integral plenum chamber
Material ----- Aluminum
Intake Manifold Adapter
Material ----- Aluminum
Ram Pipes
Quantity ----- 8
Length ----- 12.0
Construction ----- Integral with inlet manifold

STARTING

Description ----- Fuel channeled directly
from fuel pump into distribution spider into
intake ports thru bypass valve; valve actuated
by solenoid energized thru ignition switch.

EXHAUST AND VENTILATION SYSTEM

EXHAUST SYSTEM

Type ----- Dual with no resonators

MUFFLERS

Type ----- Dual, reverse flow
Construction ----- Heads and body joined
by rolled lock seam construction

Shell

Right hand ----- .036 stainless steel

Left hand ----- .036 sheet steel aluminum coating

Wrap ----- .030 indented asbestos sheet

Cover ----- .018 sheet steel aluminum coating

Heads

Right hand ----- .048 stainless steel

Left hand ----- .048 sheet steel aluminum coating

Baffles

Right hand ----- 4; #1 & #4 .036 stainless steel
#2 & #3 .036 sheet steel alum. ctg.

Left hand ----- 4; .036 sheet steel aluminum ctg.

Length, body ----- 21.88

Width (I.D.) ----- 5.00

Height (I.D.) ----- 9.25

EXHAUST PIPES

Dimensions (O.D.)

250 HP engine (all transmissions) and 300 HP engines

(Powerglide) ----- 2.00

300, 350, 365 & 375 HP engines, 3-speed and 4-speed

transmissions ----- 2.50

Wall thickness

250 HP engine (all transmissions) and 300 HP engines

(Powerglide) ----- .067-.081

300, 350, 365 & 375 HP engines, 3-speed and 4-speed

transmissions ----- .084-.104 laminated

425 HP (396 Cu. In.) ----- .084-.104 laminated

TAIL PIPES

Dimensions (O.D.) ----- 2.00

Wall thickness ----- .023

ENGINE VENTILATION

Type ----- Closed-positive;

fumes withdrawn into induction system from crankcase via hosing connected to oil filler tube and fitting with a metering orifice at base of carburetor (orifice for fuel injection engine at front of intake manifold).

LUBRICATION SYSTEM

GENERAL

Type ----- Controlled full pressure

Main bearings ----- Pressure

Connecting rods ----- Pressure

Piston pins ----- Splash

Cylinder walls ----- Pressure, jet cross sprayed

Camshaft bearings ----- Pressure

Valve lifters ----- Pressure

Rocker arms ----- Pressure

Timing gears ----- Centrifugally oiled from front

camshaft bearing

Oil pressure sending unit

Type ----- Bourdon tube

Actuation ----- Oil pressure

Oil filler

Gap ----- Positive seal

Location ----- Left front of intake manifold

CRANKCASE CAPACITY (Quarts)

Refill ----- 4.0; L76, L79 & L84 - 5.0

Refill with filter change ----- 5.0; L76, L79 & L84 - 6.0

OIL PUMP

Type ----- Gear

Normal oil pressure ----- 30-45 PSI @ 1500 RPM

V8 396 --- 50-75 PSI @ 2000 RPM

Intake Type ----- Fixed

Capacity (GPM @ Eng RPM) ----- 4.3 @ 2000

V8 396 --- 6 @ 2000

Regulator valve ----- Opens between 40-45 lbs

OIL FILTER

Type ----- Full flow, replaceable element

Location ----- Left rear underside of engine

Capacity (qts) ----- 1

By-pass valve ----- Opens between 9 to 11 PSI
drop in pressure

LUBRICANT GRADES AND TEMPERATURES

32 degrees F and above - SAE 20W SAE 10 or SAE 10W-30

0 degrees F and above ----- SAE 10W, or SAE 10W-30

Below 0 degrees F ----- SAE 5W or SAE 5W-20

OIL PAN

Type of drain plug ----- Hex head

Location ----- Lower rear edge of oil pan sump

Size hex head ----- .860-.875

Thread ----- 1/2-20 UNF 2A

Length ----- .081

Diameter ----- .410-.430

COOLING SYSTEM

GENERAL

Type ----- Liquid, pressurized
 250HP & 300HP Engines ----- Internal by-pass
 350HP, 375 HP & 425 HP Engines ----- External by-pass
 Capacity (with heater) ----- 19 qts
 (396 Cu.In.) 22 qts

RADIATOR

Type ----- Aluminum cross-flow
 Core Constant and Thickness
 Distance between Fins ----- .18
 Distance between Tubes ----- .55
 Thickness at Core ----- 2.88
 Frontal Area (Sq. In.) ----- 315.4
 (396 Cu.In.) 348.6

SURGE TANK

Location ----- Right side, engine compartment
 connected by hosing to top of radiator
 Capacity (Qts) ----- 2.3
 Fill Requirements ----- Half full when weather is cold

RADIATOR CAP RELIEF VALVE

Opens at ----- Approximately 13 PSI

FAN

Number of Blades ----- 5, staggered
 Diameter ----- 17.12
 Fan Pulley Pitch Diameter ----- 7.00
 Drive
 Type ----- Thermomodulated fluid coupling
 Performance at 4000 RPM Input ----- At 135°-150°F
 fan speed 3200 to 3500 RPM; at 12°F
 and below, fan speed 800-1600 RPM

THERMOSTAT

Type ----- Pellet
 Begins to Open at ----- 177°-183°F
 Fully Opened at ----- 212°F

RADIATOR HOSE

Outlet, Lower (radiator to water pump) ----- 1.75 ID
 Inlet, Upper (thermostat hsg. to radiator) ----- 1.50 ID

BELTS, CRANKSHAFT, FAN AND GENERATOR

Number Used
 250HP & 300HP Engine ----- One
 350HP, 375 HP & 425 HP Engines ----- Two
 Angle of "V" ----- 38°-42°
 Pitch Line
 Fan, Generator and Water Pump Belt ----- 54.75
 (396 Cu.In.) 56.20
 Fan and Water Pump Belt ----- 37.50
 (396 Cu.In.) 34.40
 Width ----- .380

WATER PUMP

Type ----- Centrifugal
 Capacity (GPM @ Engine RPM) ----- 57 @ 4400
 (396 Cu.In.) 82 @ 5200
 Bearing ----- Permanently lubricated double row ball
 Drive ----- Fan belt
 Ratio (pump to engine RPM) ----- .949:1

DRAIN LOCATIONS AND TYPE

Radiator ----- Petcock, left side at bottom
 Engine Block ----- Plug; right and left center

ELECTRICAL SYSTEM

SUPPLY SYSTEM

BATTERY

Voltage ----- 12
 Capacity (SAE) ----- 61 amp hr @ 20 hr rate
 Total Number of Plates ----- 66
 Number of Cells ----- 6
 Terminal Grounded ----- Negative
 Location ----- Rear of left wheelhouse

GENERATOR

Type ----- Diode rectified
 Rating
 Amps ----- 9-37
 Volts ----- 10-15

Drive ----- By fan belt
 Pulley Pitch Diameter ----- 2.70
 Ratio (Gen to Engine Speed) ----- 2.46:1

REGULATOR

Type ----- Two unit; vibrator
 Voltage Regulator
 Voltage ----- 13.8-14.8 @ 85°F
 Field Relay (Combination light & field relay)
 Closing Voltage ----- 1-3 Volts @ 80°F
 Location ----- Right side from engine compartment

ELECTRICAL SYSTEM—Cont'd.

STARTING SYSTEM

STARTING MOTOR

Rotation (drive end view) ----- Clockwise
 Test Conditions --- Engine at operating temperature
 No Load Test
 Amps ----- 65-100
 Volts ----- 10.6
 RPM ----- 3600-5100
 Motor Drive
 Engagement ----- Solenoid
 Pinion meshes at ----- Rear
 Pinion tooth no. ----- 9
 Flywheel tooth no. ----- 153
 Mounting ----- Bolted to clutch housing

IGNITION SYSTEM

DISTRIBUTORS ----- Refer to chart below

COIL

Type ----- 12 Volt
 Amperes Drawn
 Engine stopped ----- 4.0
 Engine idling ----- 1.8

SPARK PLUGS

Make ----- AC44
 396 Cu.In. - AC43N
 Thread Size (mm) ----- 14
 Gap ----- .033-.038
 Torque ----- 25 lb ft

CABLE ----- Linen core impregnated
 with electrical conducting material and
 insulation of rubber with neoprene jacket

DISTRIBUTORS	V-8 327 Cu.In. 250 HP	V-8 327 Cu.In. 300 HP	V-8 327 Cu.In. 350 HP	V-8 327 Cu.In. 365 HP	V-8 327 Cu.In. 375 HP	V-8 396 Cu.In. 425 HP
Make	Delco-Remy					
Model	1111076	1111087	1111069	1111070	1111093	
Type	Single Breaker					
Cam Angle	28° - 32°					
Breaker Gap	.019 (new)					
Breaker Arm Tension	19-23 oz					
Centrifugal Advance Begins (RPM)	750		800		1000	
Max Degrees @ RPM	26 @ 4100		24 @ 2350		28 @ 4600	
Vacuum Advance Begins (In. Hg)	6		4		8	
Max Degrees @ In. Hg	22 @ 12		16.5 @ 8.2		15 @ 15.5	
Timing (Initial Design Setting)	8°		10°		10°	
Crankshaft Degrees @ RPM (with vacuum spark line disconnected)	BTC @ 550		BTC @ 650		BTC @ 700	
Timing Mark Location	Harmonic Balancer					

327 CUBIC INCH V-8 ENGINES

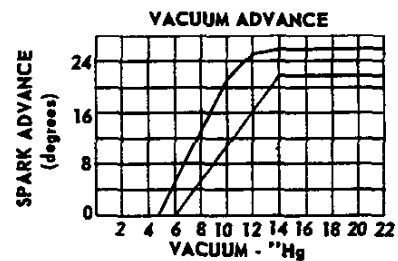
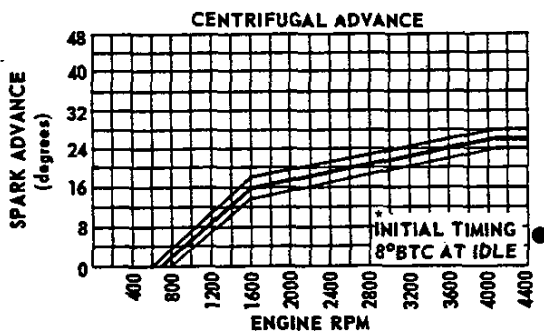

CLUTCHES

GENERAL

Type ----- Single disk, dry centrifugal
 Clutch cover and pressure plate assembly
 Effective plate load, lb ----- 2100-2300
 (V8-396) 2300-2600
 Pressure plate material ----- Nodular iron
 (V8-396) Cast iron
 Clutch spring
 Type ----- Circular plate diaphragm,
 bent finger design
 Material ----- Spring steel, heat treated
 Driven plate assembly
 Cushions ----- Flat spring steel
 between friction rings
 Dampers ----- 10 springs, 5 sets of 2
 Friction rings
 OD ----- 10.0
 (V8-396) 10.4
 ID ----- 6.5
 Total (sq. inches) ----- 90.7
 (V8-396) 103.5
 Material ----- Premium woven asbestos

Flywheel

Ring gear
 Material ----- HR steel, heat treated
 No. of teeth ----- 153
 PD ----- 12.75
 Attachment ----- Shrink fit
 Bearings
 Release
 Type ----- Single row ball
 Lubrication ----- Packed with high
 temperature, high viscosity grease
 Pilot
 Type ----- Sintered powdered bronze bushing
 Lubrication ----- Oil impregnated
 Controls
 Clutch fork ----- Drop forged steel,
 pivot mounted on ball
 Pedal mounting ----- Pendant, from brace on dash
 Lubrication ----- Crossover shaft
 Clutch housing material ----- Aluminum alloy

TRANSMISSIONS

3- AND 4-SPEED (RPO M20)

CASE

Material -----
 3-Speed ----- Cast iron
 4-Speed ----- Aluminum

GEARSHIFT

Type ----- Lever
 Location ----- Floor mounted between seats
 Control ----- Remote

LUBRICANT

Type ----- Military MIL-L-2105-B
 Capacity, pts
 3-Speed ----- 2
 4-Speed ----- 2.5

EXTENSION

Material ----- Aluminum
 Oil seal ----- Steel encased double seal
 of spring loaded rubber or felt

GEARS

Type ----- Helical
 Material ----- Forged steel, hardened
 Synchronization
 3-Speed ----- Second and third
 4-Speed ----- All forward gears
 Constant mesh gears
 3-Speed ----- Second
 4-Speed ----- All forward gears
 Sliding gears
 3-Speed ----- First and reverse
 4-Speed ----- Reverse
 Ratios
 3-Speed
 First ----- 2.58:1
 Second ----- 1.48:1
 Third ----- 1.00:1
 Reverse ----- 2.58:1
 4-speed
 Reg. prod. and L75 engines
 First ----- 2.56:1
 Second ----- 1.91:1
 Third ----- 1.48:1
 Fourth ----- 1:1
 Reverse ----- 2.64:1
 L79, L76, L84 (327 Cu.In.) & L78 (396 Cu.In.)
 First ----- 2.20:1
 Second ----- 1.64:1
 Third ----- 1.28:1
 Fourth ----- 1:1
 Reverse ----- 2.27:1

AUTOMATIC TRANSMISSION - RPO M35

GENERAL

Type ----- Automatic hydraulic torque converter
with planetary gear system for low and reverse

Selector lever
Location ----- Floor
Operation ----- Actuates manual valve
in hydraulic control system

Quadrant positions ----- P-R-N-D-L

Parking brake
Type ----- Positive
Operation ----- Applied by selector lever
through spring-loaded linkage

Method of cooling ----- Air heat exchanger
Flywheel assembly ----- Steel stamping with
welded on ring gear

HYDRAULIC CONTROLS

Manual valve type ----- Spool
Pressure regulator valve type ----- Spool

* Pressure range, psi @ idle

Drive
Minimum ----- 49
Maximum ----- 53

Low
Minimum ----- 128
Maximum ----- 137

Reverse
Minimum ----- 81
Maximum ----- 91

CONVERTER ASSEMBLY

Type ----- Three element
Pump
Description ----- Sheet steel shells and
vanes; welded to converter housing

Turbine
Description ----- Sheet steel shells and
vanes, supported in converter cover; operation
independent of cover and pump housing

Stator
Description ----- Aluminum air foil supported on a
stationary sleeve by an over-running
clutch of cam and roller design

Stall torque ratio ----- 2.10:1
Diameter (nominal) ----- 11.75

PLANETARY GEAR SET

Type ----- Compound planetary
Range
Drive ----- 1.76:1 to 1:1
Low ----- 1.76:1
Reverse ----- 1.76:1
Low band ----- Three linked circular segments
Low band servo ----- Piston with release spring
and inner cushion spring

CASE

Material ----- (One piece) aluminum

OUTPUT SHAFT RPM (VEHICLE SPEED MPH)

N/V factor	Reg. prod.	L75
Upshift	39.8	42.2
Closed throttle	650 (16)	660 (16)
Detent touch	2130 (54)	2350 (61)
Full detent	2495 (58)	2750 (65)
Downshift		
Closed throttle	605 (15)	615 (15)
Detent touch	825 (21)	885 (21)
Full detent	2355 (59)	2590 (61)

HIGH CLUTCH

Type ----- Multi-disk
Drive plates
Description ----- Waved steel
with bonded organic facings
Number ----- 4

Driven plates
Description ----- Flat steel
Number ----- 5

REVERSE CLUTCH

Type ----- Multi-disk
Drive plates
Description ----- Flat steel with
bonded organic facings
Number ----- 6

Driven plates
Description ----- Flat steel
Number ----- 5

TORQUE MULTIPLICATION

Maximum overall ratio ----- 3.70:1
Low and reverse ----- 3.70:1 to 1.76:1

LUBRICANT

Type ----- A, Suffix A
Capacity (pts)
Dry ----- 18
Refill ----- 3

GOVERNOR

Type ----- Centrifugal
Operation ----- Regulates pump oil pressure
to automatic shift control valve
Drive ----- Mounted on output shaft
Location ----- In extension

OIL PUMPS

Type ----- Internal-external gear
Number ----- Two, front and rear
Function ----- To supply pressure

Front pump
Drive ----- Converter pump
Function ----- Supply main system
pressure at low vehicle speeds

Rear pump
Drive ----- Output shaft
Function ----- Supply main system pressure
at high vehicle speeds and during push starts

* - Conditions: 450 RPM input, 25 inches hg vacuum.

AMA Specifications — Passenger Car

MAKE OF CAR CORVETTE MODEL YEAR 1965 DATE ISSUED 5-28-64 REVISED(6)

GENERAL SPECIFICATIONS

(All dimensions in inches unless otherwise indicated)

MODEL	19400	Additional Information Page No.:	19437	19467			
Wheelbase (L101)		23	98.0				
Tread	Front (W101)	22	56.8				
	Rear (W102)	22	57.6				
Maximum Overall Dimensions	Length (L103)	23	175.1				
	Width (W103)	22	69.2 (W106 is 69.6)				
	Height (H101)	24	49.6	49.8			
Transmission— (Specify trade name - opt., nor available)	Manual Synchronesh		Std. Engine	L75	L79	L76	L84
			3-spd. std.	4-spd. opt.	4-spd. opt.		
	Overdrive		NA				
	Automatic Power-glide	16	Optional		NA		
Axle ratio	Manual	17	3.36		3.70		
	Overdrive	17	NA				
	Automatic	17	3.36		NA		
Tire size		18	7.75 x 15				
Engine	Type, no. cyl., valve arr.	2	90° OHV V-8				
	Fuel system (Carb., other)	8	Carburetor			Fuel Injection	
	Bore and stroke	2	4.00 x 3.25				
	Piston displ., cu.in.	2	327				
	Std. compression ratio	2	10.5		11.0		
	Max. bhp at engine rpm	2	250 @ 4400	300 @ 5000	350 @ 5800	365 @ 6200	375 @ 6200
	Max. torque at rpm	2	350 @ 2800	360 @ 3200	360 @ 3600	350 @ 4000	350 @ 44-4800

AMA Specifications – Passenger Car

The information contained herein is prepared, distributed by, and is solely the responsibility of the automobile manufacturing company to whose products it relates. Questions concerning these specifications should be directed to the manufacturer whose address is shown below. This uniform specification form was developed by the automobile manufacturing companies under the auspices of the Automobile Manufacturers Association.

MANUFACTURER Chevrolet Motor Division General Motors Corp.	CAR NAME CORVETTE	
MAILING ADDRESS Chevrolet Engineering Center 30003 Van Dyke, Warren, Michigan 48090	MODEL YEAR 1965	ISSUED: 9-28-64 REVISED (e)

NOTES:

1. The Specifications herein are those in effect at date of compilation and are subject to change without notice by the manufacturer.
2. **UNLESS OTHERWISE INDICATED:**
 - a. Specifications apply to standard models without optional equipment. Significant deviations are noted.
 - b. Nominal design dimensions are used throughout these specifications.

TABLE OF CONTENTS

General Specifications 1	Drive Units 15	Rear Suspension 21	Weights 23
Engine - Mechanical 2	Brakes 18	Station Wagon 1a	Index 24
Electrical 10	Front Suspension & Steering . . 19		

BODY—TYPES AND STYLE NAMES—	Body type, number of passenger & style names; use manufacturer's code for series & body style.
Model 19467	2-door Convertible, 2-passenger
Model 19437	2-door Sport Coupe, 2-passenger

AMA Specifications—Passenger Car

MAKE OF CAR CORVETTE MODEL YEAR 1965 DATE ISSUED 9-28-64 REVISED (a)

MODEL 19400	Base 250 HP	RPO-L79 300 HP	RPO-L79 350 HP	RPO-L76 365 HP	RPO-L84 375 HP
--------------------	----------------	-------------------	-------------------	-------------------	-------------------

ENGINE—GENERAL

Type, no. cyls., valve arr.		90° OHV V-8			
Bore and stroke (nominal)		1.00 x 3.25			
Piston displacement, cu. in.		327			
Bore spacing (C/L to C/L)		4.4			
No. system (front to rear)	L. Bank	1-3-5-7			
	R. Bank	2-4-6-8			
Firing order		1-8-4-6-3-5-7-2			
Compress. ratio (nominal)		10.5:1		11.0:1	
Cylinder Head Material		Cast alloy iron			
Cylinder Block Material		Cast alloy iron			
Cylinder Sleeve—Wet, dry, none		None			
Number of mounting points	Front	Two			
	Rear	One			
Engine installation angle		3°			
Taxable horsepower		51.2			
Published max. bhp* @ eng. RPM		250 @ 4400	300 @ 5000	350 @ 5800	365 @ 6200
Published max. torque* (lb. ft. @ RPM)		350 @ 2800	350 @ 4000	360 @ 3800	350 @ 4000
R = - premium		Premium			
Idle speed (spec. neutral or drive)	Manual	400-500 RPM in Neutral		700 RPM in Neutral	
	Automatic	450-500 RPM in Drive		----	

ENGINE—PISTONS

Material		Cast aluminum	Aluminum impact
Description and finish		Flat head; Slipper skirt	Domed head; Slipper skirt
Weight (piston only) oz.		21.60	20.40
Clearance (limits)	Top land	.0365-.0455(a)	.0395-.0425(b)
	Skirt	Top	.0005-.0011
		Bottom	.0039-.0045
Ring groove depth	No. 1 ring	.2217-.2283	
	No. 2 ring	.2217-.2283	
	No. 3 ring	.2038-.2103	
	No. 4 ring	.2038-.2103	

*Max. bhp (brake horsepower) and max. torque corrected to 60° F and 29.92 in. Hg atmospheric pressure.

(a) - Measured at 2.24 from top of piston.

(b) - Measured at 2.32 from top of piston.

MAKE OF CAR CORVETTE MODEL YEAR 1965 DATE ISSUED 7-28-64 REVISED (•) _____

GENERAL SPECIFICATIONS — DIMENSIONS

(All dimensions in inches unless otherwise indicated)
(Supplemental data available on request)

MODEL	19400	Ref. No.	19437	19467
-------	-------	----------	-------	-------

FRONT COMPARTMENT

Shoulder room	W3		18.4
Max. eff. leg room - accelerator	L34		1.7
Effective head room	H61	37.0	38.5
H Point to Heel point	H30		3.9
Upper body opening to ground	H50	16.8	15.6

REAR COMPARTMENT NA

Shoulder room	W4		
H Point couple distance	L50		
Minimum effective leg room	L51		
Effective head room	H63		

STATION WAGON—THIRD SEAT NA

Shoulder room	W85		
Effective leg room	L86		
Effective head room	H86		

LUGGAGE COMPARTMENT

Usable luggage capacity (See instr.)	V1	10.6 cu. ft.	8.1 cu. ft.
Liftover height	H195		NA
Position of spare tire storage		Under fuel tank (accessible from underside of vehicle)	
Method of holding lid open			NA

STATION WAGON—CARGO SPACE NA

Minimum distance between wheel houses at floor level	W201	
Rear end opening width at belt	W204	
Floor length from back of front seat at floor level to inside of closed tail gate	L202	
Minimum horizontal distance from top rear of front seat back to inside of tail gate at belt	L204	
Maximum height - floor covering to headlining at centerline of rear axle	H201	
Maximum height of rear opening - tail and lift gates open	H202	
Cargo volume index (cu.ft.)	$\frac{W4 \times L204 \times H201}{1728}$	V2

AMA Specifications – Passenger Car

MAKE OF CAR CORVETTE MODEL YEAR 1965 DATE ISSUED 9-28-64 REVISED(*)

POWER TEAMS

(Indicate whether standard or optional)

MODEL AVAILABILITY	ENGINE					TRANSMISSION	AXLE RATIO (Std. first)			
	Displ. cu. in.	Carburetor	Compr. Ratio	BHP @ RPM	Torque @ RPM		"A"	"B"	"C"	"D"
19400	327	4-Bbl	10.5:1	250	350	3-Speed	3.36:1	-	-	-
				4000	2800	4-Speed *	3.36:1	-	3.08:1	-
				Powerglide *	3.36:1	-	-	-		
		Large* 4-Bbl Alum.	10.5:1	300	360	4-Speed *	3.36:1	-	3.08:1	-
				@	@	Powerglide *	3.36:1	-	-	-
				5000	3200	-	-	-		
Large* 4-Bbl. Carb.	11.0:1	350	360	3-Speed	3.36:1	-	-	-		
		@	@	4-Speed *	3.70:1	3.36:1	4.11:1			
5800	3800	-	-	3.55:1	3.08:1	4.56:1				
Large* 4-Bbl Carb.	11.0:1	365	350	4-Speed *	3.70:1	3.36:1	4.11:1			
		@	@	-	-	3.08:1	4.56:1			
6200	4000	-	-	-	-	-				
Fuel * In- jection	11.0:1	375	350	4-Speed *	3.70:1	3.36:1	4.11:1			
		@	@	-	-	3.08:1	4.56:1			
6200	44- 4800	-	-	-	-	-				
*-Optional A-General Purpose Standard (Also available as positraction) B-Special Purpose or Mountain (Available as positraction only) C-Performance Cruise (250 HP & 300 HP Engines available as positraction all other engines positraction only) D-High performance (Available as positraction only)										

AMA Specifications - Passenger Car

MAKE OF CAR CORVETTE	MODEL YEAR 1965	DATE ISSUED 9-28-64	REVISED (*)
MODEL 19400	Base 250 HP	RPO-L75 300 HP	RPO-L79 350 HP
		RPO-L76 365 HP	RPO-184 375 HP

327 Cu. In. V-8 Engine

ENGINE-RINGS

Function (top to bottom)	No. 1, oil or comp.	Compression
	No. 2, oil or comp.	Compression
	No. 3, oil or comp.	Oil
	No. 4, oil or comp.	
Compression	Description - material, type, coating, etc.	Upper: Cast alloy inside bevel Coating - chrome plate O. D. Molybdenum Lower: (a) Cast alloy iron-Molybdenum coating
	Width	Upper: .0775-.0780 ; Lower: .0770-.0775
	Gap	Upper .013-.023 ; Lwr. .013-.025 Upper & Lower .013-.025
	Oil	Multi-piece (2 rails and one spacer expander) Rails - Steel, chrome plated OD Expander - Stainless steel
Expanders	Width	.1840-.1880 (assembled)
	Gap	.015-.055
		In oil ring assembly

ENGINE-PISTON PINS

Material	Chromium Steel	
Length	2.990-3.010	
Diameter	.9270-.9273	
Locked in rod, in piston, floating, etc.	Locked in rod	
	In rod or piston	None
Bushing Material		
Clearance	In piston	.00015-.00025
	In rod	.00045-.00055
Direction & amount offset in piston	Major thrust side .060 On center	

ENGINE-CONNECTING RODS

Material	Drop forged steel	
Weight (oz.)	20.00	
Length (center to center)	5.699-5.701	
Bearing	Material & Type	Premium aluminum
	Overall length	.807
	Clearance (limits)	.0007-.0028
	End play	.009-.013

(a) One ring (wear resistant coating) and steel expander

AMA Specifications—Passenger Car

MAKE OF CAR CORVETTE	MODEL YEAR 1965	DATE ISSUED 9-28-64			REVISED (*)
MODEL 19400	Base 250 HP	327 Cu. in. V-8 Engines RPO-1.75 300 HP	RPO-1.79 350 HP	RPO-1.76 365 HP	RPO-1.84 375 HP

ENGINE—CRANKSHAFT

Material	Forged steel					
Vibration damper type	Rubber mounted inertia					
End thrust taken by bearing (No.)	Five					
Crankshaft end play	.002-.006					
Main bearing	Material & type		Premium aluminum exc. No. 5 steel backed babbitt		Premium aluminum	
	Clearance		#1 thru #4 .0008-.0034; #5 .0010-.0036			
	Journal dia. and bearing overall length	No. 1	2.3013 x .752		2.3009 x .752	
		No. 2	2.3009 x .752			
		No. 3	2.3009 x .752			
		No. 4	2.3009 x .752			
		No. 5	2.3006 x 1.1824			
		No. 6	None			
Dir. & amt. cyl. offset		None				
Crankpin journal diameter		1.999 - 2.000				

ENGINE—CAMSHAFT

Location	In block above crankshaft					
Material	Cast alloy iron					
Bearings	Material	Extra life steel backed babbitt				
	Number	Five				
Type of Drive	Gear or chain		Chain			
	Crankshaft gear or sprocket material		Steel sprocket			
	Camshaft gear or sprocket material		Cast alloy iron			
	Timing chain	No. of links		40		
		Width		.875		
		Pitch		.500		

ENGINE—VALVE SYSTEM

Hydraulic lifters (Std, opt, NA)	Standard		Mechanical
Valve rotator, type (Intake, exhaust)	None		
Rocker ratio	1.5:1		
Operating tappet clearances (Indicate hot or cold)	Intake	Zero	.025
	Exhaust	Zero	.025
Timing marks on flywheel, damper, other	Harmonic Balancer		

(Continued)

AMA Specifications—Passenger Car

MAKE OF CAR	CORVETTE	MODEL YEAR	1965	DATE ISSUED	9-28-64	REVISED (*)	
MODEL	19400	Base	250 HP	327 Cu. in. V-8	RPO-1.75	300 HP	RPO-1.76
					RPO-1.79	350 HP	RPO-1.84
						RPO-1.76	365 HP
							RPO-1.84
							375 HP

ENGINE—VALVE SYSTEM (cont.)

Timing *	Intake	Opens (°BTC)	32° 30'	54"	60° 50'	
		Closes (°ABC)	87° 30'	108°	105° 23'	
		Duration - deg.	300°	342°	346° 13'	
	Exhaust	Opens (°BSC)	74° 30'	102°	108° 50'	
		Closes (°ATC)	45° 30'	60°	57° 23'	
		Duration - deg.	300°	342°	346° 13'	
Valve opening overlap		78°	114°	118° 13'		
Intake	Material		Alloy steel			
	Overall length		4.870-4.889			
	Actual overall head dia.		1.935-1.945	2.017-2.023		
	Angle of seat & face		46° (seat) 45° (face)			
	Seat insert material		None			
	Stem diameter		.3404-.3417			
	Stem to guide clearance		.0010-.0027			
	Lift (@ zero lash)		.3987	.4472	.4851	
	Outer spring press. and length	Valve closed (lb. @ in.)	78-86 @ 1.66			
		Valve open (lb. @ in.)	170-180 @ 1.26			
	Inner spring press. and length	Valve closed (lb. @ in.)	Spring Damper			
		Valve open (lb. @ in.)	Spring Damper			
	Exhaust	Material		High Alloy Steel (Aluminized Face)		
		Overall length		4.913-4.933	4.891-4.910	
Actual overall head dia.		1.495-1.505	1.595-1.605			
Angle of seat & face		46° (seat) 45° (face)				
Seat insert material		None				
Stem diameter		.3410-.3417				
Stem to guide clearance		.0010-.0027				
Lift (@ zero lash)		.3987	.4472	.4851		
Outer spring press. and length		Valve closed (lb. @ in.)	78-86 @ 1.66			
		Valve open (lb. @ in.)	170-180 @ 1.26			
Inner spring press. and length		Valve closed (lb. @ in.)	Spring Damper			
		Valve open (lb. @ in.)	Spring Damper			

ENGINE—LUBRICATION SYSTEM

Type of lubrication (splash, pressure, nozzle)	Main bearings	Pressure
	Connecting rods	Pressure
	Piston pins	Splash
	Camshaft bearings	Pressure
	Tappets	Pressure
	Timing gear or chain	Nozzle
	Cylinder walls	Pressure, jet cross sprayed

* Including ramps on 250, 300 & 250 HP opens with .025 lash on 365 & 375 HP

(Continued)

AMA Specifications – Passenger Car

MAKE OF CAR	CORVETTE	MODEL YEAR	1965	DATE ISSUED	9-28-64	REVISED (a)	
MODEL	19400	Base	RPO-L75	RPO-L79	RPO-L76	RPO-L84	
		250 HP	300 HP	350 HP	365 HP	375 HP	

ENGINE—LUBRICATION SYSTEM (cont.)

Oil pump type	Gear
Normal oil pressure (lb. @ engine rpm)	30-45 PSI @ 1500
Oil pressure sending unit (elect. or mech.)	Mechanical (direct pressure to Bourdon tube)
Type oil intake (floating, stationary)	Stationary
Oil filter system (full flow, partial, other)	Full Flow
Filter replacement (element, complete)	Element
Capacity of crankcase, less filter-refill (qt.)	4 5
Oil grade recommended (SAE viscosity and temperature range)	* 32° F and Above ----- SAE 20W, SAE 20 or SAE 10W-30 0° F and Above ----- SAE 10W, or SAE 10W-30 Below 0° F ----- SAE 5W or SAE 5W-20
Engine Service Requirement (MM, MS, etc.)	MS or DG

ENGINE—EXHAUST SYSTEM

Type (single, single with cross-over, dual, other)	Dual
Muffler No. & type (reverse flow, straight thru, separate resonator)	Two; reverse flow, no resonators
Exhaust pipe dia. (O.D. & wall thickness)	Std. Eng. & 300 HP Eng. with P/Glide - 2.00 x .067-.081 300HP, 350HP, 365HP & 375HP with man. trans. - 2.50x.084-.104
Tail pipe diameter (O.D. & wall thickness)	2.00 x .023

ENGINE—CRANKCASE VENTILATION SYSTEM

Type (ventilates to atmos., induction system, other)	Standard	Induction system	
	Optional		
Control unit	Make and model	AC	
	Location	Carburetor base	Intake Mnf'ld
	Energy source (manifold vacuum, carburetor air stream, other)	Carburetor air stream	Manifold Vacuum
	Control method (variable orifice, fixed orifice, other)	Fixed orifice	
Complete system	Discharges (to intake manifold, carb. air intake, air cleaner intake, other)	intake manifold	
	Air inlet (breather cap, carburetor air cleaner, other)	Filtered side of air cleaner	
	Flame arrestor (screen, check valve, other)	Screen	

* - SAE 5W-30 can be used as an alternate for 5W; 5W-20 or 10W-30.

AMA Specifications - Passenger Car

MAKE OF CAR	CORVETTE	MODEL YEAR	1965	DATE ISSUED	28-64	REVISED (a)
MODEL	19400	Base	250 HP	RPO-1.75	RPO-L79	RPO-1.76
			300 HP	350 HP	365 HP	375 HP

ENGINE-FUEL SYSTEM

(See Supplement to Page 8 for Details of Fuel Injection, Supercharger, etc. if used)

Induction type: Carburetor, fuel injection, supercharger.		Carburetor	Fuel Injection
Fuel Tank	Capacity (gals.)	20 (a)	
	Filler location	Center at rear deck	
Fuel Pump	Type (elec. or mech.)	Mechanical	
	Locations	Lower right front of engine	
	Pressure range	5.25-6.50 PSI	6.00-7.50 PSI
Vacuum booster (std., optional, none)		None	
Fuel Filter	Type	Fine mesh plastic strainer in gas tank	
	Locations	Sintered bronze filter in carb. inlet on 250 HP (b)	
Carburetor	Choke type	Automatic	
	Intake manifold heat control (exhaust or water)	Exhaust	
	Air chr. type	Standard	Oil wetted, polyurethane
	Optional		

CARBURETOR SUPPLEMENTARY INFORMATION

Model Usage	Engine Displ.	Transmission	Carburetors		No. Used and Type	Barrel Size
			Make	Model		
19400	327 250 hp	3-Speed 4-Speed Powerglide	Carter	3846247	One; 4-Bbl Down-draft	1.4375 (P) 1.4375 (S)
	327 300 hp	3-Speed 4-Speed Powerglide	Carter	3851761 3851762	One 4-Bbl Alum. Down-draft	1.5625 (P) 1.6875 (S)
	327 350 hp	4-Speed	Holley	3849804	One 4-Bbl Down-draft	1.561 (P) 1.561 (S)
	327 365 hp	4-Speed	Holley	3849804	One 4-Bbl Down-draft	1.561 (P) 1.561 (S)
	327	4-Speed	Refer to supplement page 8A and 8B.			

(a) - 36 gallon fiberglass tank available optionally.
 (b) - In-line paper element, between fuel pump and carburetor on L75, 79, 76 & 84.

AMA Specifications – Passenger Car

Page 6A

MAKE OF CAR CORVETTE MODEL YEAR 1965 DATE ISSUED 9-28-64 REVISED (*)

SUPPLEMENTARY INFORMATION

MODEL 19400

FUEL INJECTION - RPO-L84

GENERAL

Make ----- Rochester Products
Model ----- 7017380
Type ----- Mass air flow with continuous fuel injection

AIR INDUCTION

Description ----- Outside air ducted thru air cleaner to air meter
Outside air ducting
Location ----- Left side of engine
Air cleaner
Type ----- Oil-wetted, polyurethane element; conical
Air meter
Flow control ----- Throttle valve
Flow measurement ----- Annular venturi
Cold enrichment
Type ----- Choke
Action ----- Automatic, bi-metallic spring and exhaust heat

FUEL METER

Flow control ----- Continuous flow pump with diaphragm controlled bypass; system feeds measured amounts of fuel directly to intake ports where orifice injection nozzles direct fuel to intake valves.

Pump

Type ----- Gear
Drive ----- Flexible shaft from distributor
Output psi, maximum

Bypass system

Control ----- Diaphragm controlled spill valve - by vacuum from air meter annular venturi

Injection nozzles

Quantity ----- 8
Type ----- Continuous flow
Material ----- Brass
Location ----- On intake manifold above intake ports
Orifice diameter ----- .0118

AMA Specifications – Passenger Car

Page 7

MAKE OF CAR CORVETTE MODEL YEAR 1965 DATE ISSUED 9-28-64 REVISED (*)

AMA Specifications – Passenger Car

MAKE OF CAR CORVETTE MODEL YEAR 1965 DATE ISSUED 9-28-64 REVISED (*)

SUPPLEMENTARY INFORMATION

MODEL 19400

FUEL INJECTION - RPO-L84 (Continued)

DISTRIBUTION SYSTEM

Intake manifold

Type ----- Integral plenum chamber

Material ----- Aluminum

Intake manifold adapter

Material ----- Aluminum

Ram pipes

Quantity ----- 8

Length ----- 12.0

Construction ----- Integral with inlet manifold

STARTING

Description ----- Fuel channeled directly from fuel pump into distributor spider into intake ports thru bypass valve; valve actuated by solenoid energized thru ignition switch.

AMA Specifications -- Passenger Car

MAKE OF CAR <u>CORVETTE</u>	MODEL YEAR <u>1967</u>	DATE ISSUED <u>1/28/67</u>	REVISED <u>(0)</u>
MODEL <u>19400</u>	177 Cub. In. V-8 Engines Name RPO-1.75 RPO-1.79 RPO-1.76 RPO-1.84 250 HP 300 HP 350 HP 365 HP 375 HP		

ENGINE-COOLING SYSTEM

Type system (pressure, pressure vented, atmospheric, other)		Pressure with surge tank			
Radiator cap relief valve pressure		13 PSI			
Circulation thermostat	Type (choke, bypass)	Choke			
	Starts to open at (°F)	177° - 183° F			
Water pump	Type (centrifugal, other)	Centrifugal			
	GPM @ 1000 pump rpm	57 @ 4400			
	Number of pumps	One			
	Drive (V-belt, other)	V-Belt			
Bearing type		Double row ball			
By-pass recirculation type (internal, external)		Internal	External		
Radiator core type (cellular, tube and fin, other)		Alum. num. cross flow			
Cooling system capacity	With heater (qt.)	19			
	Without heater (qt.)	18			
	Opt. equipment-specify (qt.)				
Water jackets full length of cylinder (yes, no)		Yes			
Water all around cylinder (yes, no)		Yes			
Radiator hose	Lower	Number and type (molded, straight)	One, molded		
		Inside diameter	1.75		
	Upper	Number and type (molded, straight)	One, molded		
		Inside diameter	1.50		
	By-pass	Number and type (molded, straight)	None	One, molded	
		Inside diameter	None	.725 - .765	
Fan	Number of blades & Spacing		5, Staggered		
	Diameter		17.12		
	Ratio-fan to crankshaft rev.		.940:1		
	Fan cutout type		Thermo-moldulated - viscous coupling		
	Bearing type		None		
*Drive belts (indicate belt used by letter)	Fan		A	D, E	
	Generator		A	D	
	Water Pump		A	D, E	
	Power Steering		B	-	
	Air Conditioning		C	C	

* Drive Belt Dimensions	A	B	C	D	E
Angle of V	38° - 42°				
Nominal length (SAE)	55.25	35.00	57.50	54.75	37.50
Width	.380				

AMA Specifications – Passenger Car

MAKE OF CAR CORVETTE **MODEL YEAR** 1965 **DATE ISSUED** 9-28-64 **REVISED** (a)

MODEL 19400	Base 250 HP	327 Cu. in. V-8 Engines RPO-1.75 300 HP	RPO-1.79 350 HP	RPO-1.76 365 HP	RPO-1.84 375 HP
--------------------	----------------	---	--------------------	--------------------	--------------------

ELECTRICAL—SUPPLY SYSTEM

Battery	Make and Model	Delco-Remy #1980558				
	Voltage Rtg. & Total Plates	12 Volt - 66 Plate				
	SAE Designation & Amp Hr. Rtg	61 Amp/Hr @ 20 Hr rate				
	Location	Right rear engine compartment				
	Terminal grounded	Negative				
Generator	Make	Delco-Remy				
	Model	#1100693				
	Type	Diode rectified				
	Ratio—Gen. to Cr/s rev.	2.46:1		2.00:1		
	Gen. cut-in (hot)—engine rpm					
Regulator	Make	Delco-Remy				
	Model	1119515				
	Type	Vibrator				
	Cutout relay	Closing voltage @ generator rpm	None			
		Reverse current to open				
	Regulated	Voltage	13.8-14.8 @ 85° F			
		Current				
	Voltage test conditions	Temperature	Operating			
Load		3-8 amp				
Other		None				

ELECTRICAL—STARTING SYSTEM

Starting motor	Make	Delco-Remy				
	Model	#1107320				
	Rotation (drive end view)	Clockwise				
	Engine cranking speed					
	Test conditions	Engine at operating temperatures				
	Lock test	Amps				
		Volts				
		Torque (lb. ft.)				
No load test	Amps	65-100				
	Volts	10-6				
	RPM (min.)	3600-5100				
	Switch (solenoid, manual)	Solenoid				
Motor control	Starting procedure	<p>SYNCHROMESH - Place gearshift in neutral & depress clutch to floor. POWERGLIDE - Place control lever in "N" or "P" position. INITIAL START - Press accelerator pedal to floor once to set automatic choke, then release. Turn ignition to START - release as soon as engine starts.</p>				

(Continued)

AMA Specifications – Passenger Car

MAKE OF CAR	CORVETTE	MODEL YEAR	1964	DATE ISSUED	9-28-64	REVISED (6)
MODEL	19400	Base	RPO-1.75	RPO-1.79	RPO-1.76	RPO-1.84
		250 HP	500 HP	350 HP	365 HP	375 HP

ELECTRICAL—STARTING SYSTEM (cont.)

Motor Drive	Engagement type	Positive shift solenoid				
	Pinion meshes (front, rear)	Rear				
	Number of teeth	Pinion	9			
		Flywheel	153			
	Flywheel tooth face width	1010 - 1130				

ELECTRICAL—IGNITION SYSTEM

Coil	Make	Delco-Remy				
	Model	# 1115202				
	Amps	Engine stopped	4.0			
Engine idling		1.8				
Distributor	Make	Delco-Remy				
	Model	1111076	1111087	1111069	1111070	
	Cent'fgal adv. in crankshaft degrees @ engine rpm (nominal)	Start (rpm)	750		800	
		Intermediate points deg. @ rpm				
		Max. deg. @ rpm	26 @ 4100		24 @ 2350	
	Vacuum adv. in crankshaft degrees @ in. Hg. (nominal)	Start (in. Hg.)	6			4
		Intermediate points, deg. @ in. Hg.				
		Max. deg. in. Hg.	22 @ 12		16.5 @ 8.2	
		Breaker gap (in.)	.019			
		Cam angle (deg.)	28° - 32°			
	Breaker arm tension (oz.)	19-2302				
Timing	Crankshaft deg. @ rpm.					
	Mark location	Harmonic Balancer				
	Cylinder numbering system (see page 2)	Right Bank	2-4-6-8			
		Left Bank	1-3-5-7			
Firing order (see page 2)	1-8-4-3-6-5-7-2					
Spark Plug	Make and model	AC 11				
	Thread (mm)	14				
	Tightening torque (lb. ft.)	25				
	Gap	.035 - .038				
Cable	Conductor type	Linen core impregnated with electrical conducting material				
	Insulation type	Rubber with neoprene jacket				
	Spark plug protector	Hypalon jacket				

ELECTRICAL—SUPPRESSION





Locations & type	Non-Metallic High Tension Ignition Cables
------------------	---

AMA Specifications - Passenger Car

MAKE OF CAR CORVETTE MODEL YEAR 1940 19437 19457 DATE ISSUED 7-26-60 REVISED (9)

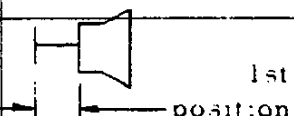
MODEL 19400 19437 19457

ELECTRICAL—INSTRUMENTS AND SWITCHES

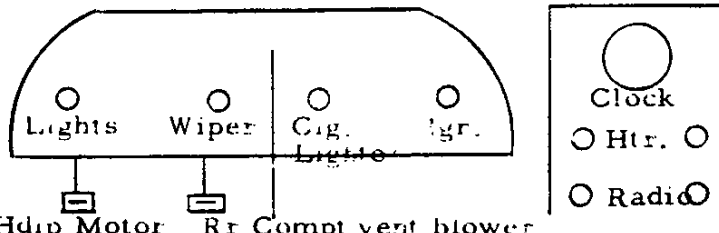
Speed-ometer	Make	AC			
	Trip odometer (yes, no)	Yes			
Charge indicator—type		Ammeter			
Temperature indicator—type		Electric gage			
Oil pressure indicator—type		Bourdon tube gage			
Fuel indicator—type		Electric gage			
Other		Mechanical tachometer			
Ignition switch	Identify positions in order and circuits controlled	ACCESSORY OFF ON START	ACCESSORY—Accessories(ign. off) OFF - off, locked ON - ignition, batt., accessories START - starter motor, spring return to ON.		
	Provision for illumination	1 1445 lamp			
	Location	Instrument panel to right of steering column			
Main lighting switch	Identify positions and lamps controlled	 1st position	 2nd position	 CW rotation	 CCW rotation
		Instru. panel lamps, parking, tail and license lamps.	Instru. panel lamps, headlamps, tail & license lamps.	Instru. panel lamps dim to off.	Instru. panel lamps off to bright; full CCW rotation.
Other light switches	Locations and lamps controlled	Dimmer; toe panel hdlp. beam and indicator. Turn signal; steering column - indicators and exterior lamps. Door jam; hinge pillars - dome and/or courtesy lamps. Stop; at brake pedal pendant - exterior stop lamps. Parking brake alarm; parking brake lever - parking brake alarm indicator. Glove compt. illumination; glove compt. - glove compt. lamp			
Other switches	Locations and devices controlled				@ Electric windows - center console. @ Auto. transmission safety switch - transmission. @ Backup lamps - transmission
	Windshield wiper	Make	Delco		
	Type	Electric two speed			
	Vacuum booster provision	None			
	Washer provision	Coordinator and vacuum reserve tank			
Horn	Type	Vibrator			
	Number used	2			
	Amp draw (each)	8.00-11.0@12.5V			

@ OPTIONAL EQUIPMENT: radio; backup lamps; power windows; auto. trans;

AMA Specifications – Passenger Car

MAKE OF CAR CORVETTE MODEL YEAR 1965 DATE ISSUED 9-28-64 REVISED ^(a)

MODEL 19400 19437 19467

ELECTRICAL—LAMP BULBS

Give quantity used and trade number, e.g., Headlamp 2-5400 S, dual headlight 2-4001, 2-4002.

Headlamps & arrangement		Dual, horizontal; outer, 2-4002; inner, 2-4001	
Headlamp beam indicator		1-1445	
Parking		2-1157	
Tail		4-1157 (a)	
Stop		4-1157 (a)	
Direction signal	Front	2-1157	
	Rear	4-1157 (a)	
	Indicator	2-1816	
License Plate		1-1155	
Oil pressure and temp. gages		1-"instrument" (shared)	
Charge and fuel gages		1-"instrument" (shared)	
Instrument		7-1816	
Clock		2-1816	Std.
Radio		1-1893	Opt.

Indicate also whether the following lamp assemblies are standard equipment, optional, or NA.

Ignition lock	1-1445		Std.
Back up	2-1156		Opt.
Dome	1-90	Std.	NA
Glove compartment	1-1893		Std.
Prkg. brake signal	1-257		Std.
Luggage compartment	NA		
Underhood	NA		
Courtesy	instru. panel, 2-90	Std.	instru. panel, 2-90; rr. compt., 1-90 Std.
Air cond. controls	1-1893		Opt.
Hdlp. position indicator	1-257		Std.
Heater controls	1-1893		Std.
Cig. lighter	1-1445		Std.
Spot lamp (portable)	1-4416		Opt.

(a) Two with backup lamps

AMA Specifications - Passenger Car

MAKE OF CAR CORVETTE MODEL YEAR 1963 DATE ISSUED 28-61 REVISED (*)

MODEL 19400

ELECTRICAL-FUSE & CIRCUIT BREAKER DATA

Use trade number of fuse, e.g., SFE-10. Indicate circuit breaker by ampere capacity suffixed by letters "C.B.", e.g., 30 C.B. Where fuse or circuit breaker protects multiple circuits indicate first use by a letter and repeat the same letter for all units protected by the same fuse or circuit breaker, e.g., Parking lamp SFE-10 (a), Direction indicator same as (a).

Headlamp	15 CB	(a)	Power windows	40 CB
Headlamp beam indicator		(a)	W/S wiper	14 CB
Parking lamp		(a)	Air conditioning	Two AGC 30
Tail lamp	AGC 10	(b)	Rr. compt. vent	one in "(f)"
Stop lamp	AGC 15	(c)	motor	(f)
Direction indicator	AGC 4	(d)		
License plate lamp		(b)		
Instrument lamp		(d)		
Ignition lamp		(d)		
Back up lamp		(b)		
Dome lamp		(c)		
Clock		(c)		
Clock lamp		(c)		
Radio	AGC 2.5	(e)		
Glove compartment lamp		(c)		
Cig. lighter		(b)		
Cig. lighter lamp		(b)		
Courtesy lamps		(e)		
Heater	AGC 10	(f)		
Heater controls lamp		(f)		
Trip gauge	AGC 10	(g)		
Fuel gauge		(g)		
Park. brake alarm		(g)		
Hdls. motor	40 CB	(h)		
Hdls. position motor		(h)		

ELECTRICAL-LOCATION OF OUTSIDE LAMPS

Distance above round to center of bulb	Tail	Lowest	21.76
		Highest	21.76
	Stop	21.76	
	Backup	21.76 (replace inboard tail lamps)	
	License, rear	21.30	
	Directional	Front	15.05
		Rear	21.76
	Headlamp	Inside	24.36
Outside*		24.36	
Distance from L of car to center of bulb	Tail	Inside	19.00
		Outside	24.00
	Stop	19.00 and 24.00	
	Backup	19.00 (replace inboard tail lamps)	
	License, rear	15.05	
	Directional	Front	28.12
		Rear	19.00 and 24.00
	Headlamp	Inside	15.36
Outside*		21.66	

* If the headlamps are used enter here.

AMA Specifications – Passenger Car

MAKE OF CAR	CORVETTE	MODEL YEAR	1965	DATE ISSUED	9-28-64	REVISED (*)
		Std. Engine	L75	L79	L76	L84
MODEL	19400	3-Spd.	4-Spd.	4-Speed	4-Speed	4-Speed

DRIVE UNITS—CLUTCH (Manual Transmission)

Make & type	Chevrolet single dry disc, centrifugal		
Type pressure plate springs	Diaphragm, bent finger design		
Effective plate pressure (lb.)	100-2300		
No. of clutch driven discs	One		
Clutch facing	Material	Woven type asbestos	
	Outside & inside dia.	10.0 & 6.5	
	Total eff. area (sq.in.)	90.7	
	Thickness	.135 ea.	
	Engagement cushioning method	Flat spring steel between cushions	
Release bearing	Type & method of lubrication	Single row ball, packed and sealed	
Torsional damping	Methods: springs, friction material	Coil springs	

DRIVE UNITS—TRANSMISSIONS

Manual (std. or opt.)	Std.	Opt.
Manual with overdrive (std. or opt.)		NA
Automatic (std. or opt.)	Optional	NA

DRIVE UNITS—MANUAL TRANSMISSION

Number of forward speeds	3	4	4	
Transmission ratios	In first	2.58	2.20	
	In second	1.48	1.64	
	In third	1.00	1.28	
	In fourth	-	1.00	
	In reverse	2.58	2.27	
Synchronous meshing, specify gears	2 & 3	All forward gears		
Shift lever location	Floor			
Lubricant	Capacity (pt.)	2.0	2.5	
	Type recommended	Military Spec. MIL-L-2105-B		
	SAE viscosity number	Summer	SAE 80	
		Winter	SAE 80	
Extreme cold		SAE 80		

AMA Specifications – Passenger Car

MAKE OF CAR	CORVETTE	MODEL YEAR	1965	DATE ISSUED	9-28-64	REVISED (*)
MODEL	19400	Std. Engine	L75	L79	L76	L84

DRIVE UNITS—MANUAL TRANSMISSION WITH OVERDRIVE NA

For transmission data see manual transmission section

Overdrive	Type (planetary or other)			
	Manual lockout (yes, no)			
	Downshift accelerator control (yes, no)			
	Minimum cut-in speed			
	Gear ratio			
	Lu- bri- cant	Capacity (pt.) (Overdrive only)		
		Separate filler (yes, no)		
Type recommended				
SAE vis- cosity number		Summer		
	Winter			
	Ext. cold			

DRIVE UNITS—AUTOMATIC TRANSMISSION

Trade name	Powerglide	NA
Type describe	Torque converter with planetary gears	
Method of Selection (Lever, Push Button or other)	Lever (floor mounted)	
Selector Pattern	P-R-N-D-L	
List gear ratios Selector Pattern and in which are used in each position	D - 1.76 and 1.0 L & R - 1.76	
Max. upshift speeds—drive range	58 65	
Max. kickdown speeds—drive range	59 61	
Torque converter	Number of elements	3
	Max. ratio at stall	2.10
	Type of cooling (air, water)	Air
Lubricant	Capacity—refill (pt.)	3
	Type recommended	A suffix A
Special transmission features		

DRIVE UNITS—PROPELLER SHAFT

Number used		One	
Type (exposed, torque tube)		Tubular, exposed	
Outer diameter x length* x wall thickness	Manual transmission	3	2 x 29.90 x .095
		4	2 x 29.90 x .095
	Overdrive transmission		NA
	Automatic transmission		2 x 29.90 x .095
			NA

*Center to center of universal joints, or to centerline of rear attachment.

(Continued)

AMA Specifications – Passenger Car

MAKE OF CAR CORVETTE MODEL YEAR 1965 DATE ISSUED 9-28-64 REVISED ^(*)

MODEL <u>19400</u>	Std. Engine	L75	L79	L76	L84
--------------------	-------------	-----	-----	-----	-----

DRIVE UNITS—PROPELLER SHAFT (cont.)

Intermediate bearing	Type (plain, anti-friction)	None
	Lubrication (fitting, prepack)	---
Universal joints	Make	Chevrolet
	Number used	2
	Type (ball and trunion, cross, other)	Cross
	Bearing	Type (plain, anti-friction)
Lubric. (fitting, prepack)		Prepack
Drive taken through (torque tube or arms, springs)		Torque control arms
Torque taken through (torque tube or arms, springs)		Torque control arms

DRIVE UNITS—REAR AXLE

Description (see instructions)		Semi-floating, overhung pinion gear				
Limited Slip differential, type		Dual disc clutches				
Drive Pinion Offset		1.5				
No. of differential pinions		2				
Gear ratios (Std. equip.)	Manual transmission	3	3.36	NA	NA	
		4	3.36	3.70	3.70	
	Overdrive transmission	NA				
Automatic transmission		3.36	NA			
Ring gear O.D. (std. ratio)		8.375				
Pinion adjustment (shim, other)		None				
Pinion bearing adj. (shim, other)		Shim				
Wheel bearing type		Taper roller				
Lubricant	Capacity (pt.)	3.7				
	Type recommended	For conventional axles, Military Spec. MIL-L-2105-B				
	SAE viscosity number	Summer	SAE 80			
		Winter	SAE 80			
		Extreme cold	SAE 80			

REAR AXLE RATIO TOOTH COMBINATIONS

(See page 3 for axle ratio usage)

Axle ratio		3.36	3.70	
No. of teeth	Pinion	11	10	
	Ring gear	37	37	

MAKE OF CAR CORVETTE MODEL YEAR 1965 DATE ISSUED 9-28-64 REVISED ^(*)

MODEL 19400

DRIVE UNITS—WHEELS

Type & material		Short spoke disc, steel
Rim (size and flange type)	Std.	15 x 5.5K
	Opt.	15 x 6L, integral ribbed aluminum casting
Attachment	Type (bolt or stud)	15 x 5.5K, bolt; 15 x 6L, adapter and spinner cap
	Circle diameter	4.75
	Number and size	15 x 5.5K, 5 hex nuts, 7/16-20 UNF-2B; 15 x 6L, 2-5/8-8 UN-2B

DRIVE UNITS—TIRES Highway, tubeless, 2-ply blackwall, unless indicated otherwise

Standard (List option below)	Size & ply	7.75 x 15-4PR
	Type - Nylon, etc.	Rayon
Rev./mile at 50 mph.		
Inflation press. (cold)	Front	24
	Rear	24
Optional tires - size and ply		7.75 x 15-4PR, rayon, W/W 7.75 x 15-4PR (4 ply) nylon (gold stripe)

BRAKES—SERVICE

Type (duo-servo, disc, balanced, etc.)		Caliper disc, 4-wheel hydraulic
Self adjusting (std., opt., N.A.)		None required
Hydraulic system type (single, dual, etc.)		Single
Master brake make & type (remote, integral, etc.)		Delco-Moraine vacuum power unit assists master cylinder; integral
Effective area (sq. in.) [*]		83.4
Gross lining area (sq. in.) ^{**}		86.3
Swept drum area (sq. in.) ^{***}		461.2
Percent brake effectiveness—front		65.0
Drum	Diameter	Front Disc 11.75 Rear Disc 11.75
	Type and material	Cast iron
Wheel cylinder bore	Front	1.875
	Rear	1.375
Master cylinder bore		1.00
Available pedal travel		5.00
Line pressure at 100 lb. pedal load		500
Shoe clearance adjustment		None required

* Excludes rivet holes, grooves, chamfers, etc.
 ** Includes rivet holes, grooves, chamfers, etc.
 *** Total swept areas for four brakes
 Widest lining contact width for each brake x its drum circumference.

(Continued)

AMA Specifications—Passenger Car

MAKE OF CAR **CORVETTE** MODEL YEAR **1967** DATE ISSUED **7-28-67** REVISIONS **(0)**

MODEL **19400**

BRAKES—SERVICE (cont.)

Bonded or riveted			Bonded	
Disc braking	Out- board Shoe	Material	Woven asbestos	
		Size (length x width x thickness)	Front wheel	5.96 x 2.21 x .41
			Rear wheel	5.96 x 2.21 x .41
		Segments per shoe	One per wheel	
	In- board Shoe	Material	Woven asbestos	
		Size (length x width x thickness)	Front wheel	5.96 x 2.21 x .41
		Rear wheel	5.96 x 2.21 x .41	
Segments per shoe		One per wheel		

BRAKES—PARKING

Type of control		Mechanical
Location of control		T handle at right of steering column
Operates on		Rear wheels
If sepa- rate from service brakes	Type (internal or external)	Internal
	Drum diameter	6.5
	Lining size (length x width x thickness)	6.77 x 1.25 x .175 ea.

FRAME or UNITIZED CONSTRUCTION

Type and description	All welded, full length, ladder constructed frame with 5 cross-members. Side rails and intermediate crossmembers box construction; rear crossmember "C" shaped. Front crossmember box-girder construction.
----------------------	--

SUSPENSION—GENERAL (See Supplemental page 19 for details on Air Suspension)*

Provision for car leveling		Front stabilizer bar
Provision for brake dip control		Mounting angle of front upper control arm
Provision for acc. squat control		None
Special provisions for car jacking		Front: 5" forward of front edge of door opening, under frame. Rear: 3" forward of wheel opening, under frame.
Shock absorber front & rear	Type	Direct double-acting, hydraulic, with freon envelope
	Make	Delco
	Piston dia.	1.00
Other special features		Full independent rear suspension; variable rate front springs

SUSPENSION—FRONT

Type and description	Independent: SLA type with coil spring and concentric shock absorber, and spherically-jointed steering knuckle for each wheel.
----------------------	--

* Air Suspension:
Air spring type
Compressor data
type
make
drive ratio

Normal operating pressures
spring rates
leveling data

(Continued)

AMA Specifications – Passenger Cars

MAKE OF CAR CORVETTE MODEL YEAR 1965 DATE ISSUED 9-28-64 REVISED (*)

MODEL 19400

SUSPENSION FRONT (cont.)

Spring	Type		Coil, variable rate
	Material		Steel alloy
	Size (coil design height & I.D.; bar length x dia.)		8.56 x 3.80 (theo); 168.50 x 6.00 (theo)
	Spring rate (lb. per in.)		195
	Rate at wheel (lb. per in.)		80
	Design load (lb. @ design height)		1380 @ 8.56
Stabilizer	Type (link, linkless, frameless)		Link
	Material & bar diameter		.9375

STEERING

Manual (std., opt., NA)			Std.	
Power (std., opt., NA)			Optional	
Adjustable steering wheel (tilt, swing, other)	Type and description		Telescoping steering column, driver adjustable	
	(std., opt., NA)		Opt.	
Wheel diameter	Manual		16.0	
	Power		16.0	
Turning diameter	Outside front	Wall to wall (l. & r.)	41.6	
		Curb to curb (l. & r.)	39.9	
	Inside rear	Wall to wall (l. & r.)	25.6	
		Curb to curb (l. & r.)	25.6	
Outside wheel angle with inside wheel at 20°			18.5°	
Manual	Gear	Type	Semi-reversible, recirculating ball nut (a)	
		Make	Saginaw	
		Ratios	16:1	
	No. wheel turns	Gear Overall		Street 20.2:1; fast 17.6:1
				Street 3.4; fast 2.92
	Type (coaxial, linkage, etc.)		Linkage	
	Make		Saginaw	
Power	Gear	Type	Same as manual	
		Ratios	16:1	
		Gear Overall		17.6:1
	Pump driven by			Crankshaft pulley
	Number wheel turns			2.92
Linkage	Type		Parallelogram	
	Location (front or rear of wheels, other)		Rear	
	Drag link (trans. or longit.)		None	
	Tie rods (one or two)		Two	

(a) Designed to provide 3" axial adjustment of steering column.

(Continued)

AMA Specifications – Passenger Car

MAKE OF CAR CORVETTE MODEL YEAR 1965 DATE ISSUED 9-28-64 REVISION (*)

MODEL 19400

STEERING (cont.)

Steering Axis	Inclination at camber (deg.)		6-1/2 to 7-1/2
	Bearings (type)	Upper	Ball stud with non-metallic brg. surfaces
		Lower	Ball stud with non-metallic brg. surfaces
	Thrust		None req'd.
Wheel alignment (range and preferred)	Caster (deg.)		P1 to P2 (curb)
	Camber (deg.)		P1/4 to P1-1/4 (curb)
	Toe-in (outside tread-inches)		7/32 to 11/32 total (curb)
Steering spindle & joint type			Steering knuckle with spherical joints
Wheel spindle	Diameter	Inner bearing	1.2493-1.2498
		Outer bearing	1.7497-1.7497
	Thread size		3/4-20 NEF-3 (modified)
	Bearing type		Taper roller

SUSPENSION—REAR

Type and description			(b)
Drive and torq. taken through (see page 17)			Torque control arms
Spring	Type		Multi-leaf
	Material		Chrome carbon steel
	Size (length x width, coil design height and I.D.; bar length & dia.)		40.30 x 2.25
	Spring rate (lb. per in.)		140
	Rate at wheel (lb. per in.)		123
	Design load (lb. at design height)		1360 @ .352 camber
	Mounting insulation type		Rubber mtg. @ diff.; vertical loading only @ shackles
	If leaf	No. of leaves	
Inserts		Type and size	(c)
		Material	Polyethylene with graphite
Shackle (comp. or tens.)		---	
Stabilizer	Type (link, linkless, frameless)		None
	Material		---
Track bar type			None

- (a) Rear wheel alignment at curb: camber-N5/6 to P1/6; toe in-0 to 1/8 total.
 (b) Full independent with fixed differential, transverse multi-leaf spring, lateral struts and universally-jointed axle shafts.
 (c) 7 liners: 2.25 (width) x 44.58, 39.08, 33.58, 29.08, 24.58, 15.58, 11.08.

AMA Specifications – Passenger Car

MAKE OF CAR	CORVETTE	MODEL YEAR	1965
		DATE ISSUED	9-28-64
		REVISED	(*)
MODEL	19400	19437	19467

BODY—MISCELLANEOUS INFORMATION

Drs. hinged (front, rear)	Front doors	Front
	Rear doors	NA
Type of finish (lacquer, enamel, other)		Lacquer
Hood counterbalanced (yes, no)		No
Hood release control (internal, external)		Internal
Vehicle (Serial) No. Location		1- Right side of hinge pillar cross brace, under glove compt. 2- With engine no.
Engine No. Location		Front right side of cylinder block
Theft protection - type		Outside door key locks
Vent window control method (crank, friction pivot)	Front	Crank
	Rear	NA
Seat cushion type	Front	Bucket-polyurethane padding
	Rear	NA
	3rd seat	NA
Seat back type	Front	Bucket-polyurethane padding
	Rear	NA
	3rd seat	NA
Windshield glass type (i.e., single curved - laminated plate)		Single curved-laminated safety plate
Backlight glass type (i.e., compound curved - tempered plate, 1 piece)		19467 soft top-flat flexible plastic, 1 piece 19467 hardtop-curved plex glass, 1 piece 19437 compound curved-solid safety plate, 1 piece
Side glass type (i.e., curved - tempered plate)		Compound curved-solid safety plate
Side glass exposed surface area		620.1 550.1
Windshield glass exposed surface area		789.7
Backlight glass exposed surface area		821.5 440.5 (soft top)
Total glass exposed surface area		2231.3 1780.3 (soft top)

BODY—CONVENIENCE EQUIPMENT (Indicate whether standard, optional or NA on each series)

Power windows	Side Windows	Optional
	Vent Windows	NA
	Backlight or tailgate	NA
Power seats (specify type as well as availability)		NA
Reclining front seat back		NA
Front seat headrest		NA
Radios (specify type as well as availability)		AM-FM, all models
Rear seat speaker		NA
Power Antenna		included with radio option
Clock		Standard
Air Conditioner (specify type and availability)		Four Seasons, all models

AMA Specifications - Passenger Car

Page 14

INDEX

	PAGE NO.		PAGE NO.
Air - Transmission	1, 16	Linings - Clutch, Brake	15, 19
Alignment	21	Lubrication	6, 7, 15, 16, 17
Amplifier	17	Luggage Capacity	16
Anti-Lock Brakes	10	Motor, Starting	10
Armature	4, 5, 6	Muffler	7
Assemblies, Generator, Water Pump	9	Overdrive	16
Assemblies, General Information, Types	Title, 1, 22	Piston Pins & Rings	2, 4
Assemblies, Exterior Dimensions	1	Pistons	13
Assemblies, Exterior Dimensions	1a	Power Brakes	20
Assemblies - Parking, Service, Power	19, 19	Power Steering	3
Assemblies	21	Power Trains	16, 17
Assemblies - Lubrication System	8	Propeller Shaft, Universal Joints	7, 8
Assemblies - Fuel Tank	4	Pumps - Oil, Fuel	7
Assemblies - Lubricants	4	Water	5
Assemblies - Engine Crankcase	15, 16	Radiator, hoses	13, 17
Assemblies - Transmission and Overdrive	15, 16	Ratios - Axle	17, 2, 3
Assemblies - Rear Axle	2, 8	Compression	20
Assemblies - Steering	21	Steering	15, 16
Assemblies - Brake	8	Transmission	13, 17
Assemblies - Ignition	14	For Axle	10
Assemblies - Electrical System	10, 11, 12, 13, 14	Regulator - Generator	18
Assemblies - Engine	1, 2	Rims	4
Assemblies - Bore, Stroke, Displacement, Type	1, 2	Rings, Piston	4
Assemblies - Compression Ratio	1, 2	Rods - Connecting	19
Assemblies - Firing Order, Cylinder Numbering	1, 2	Shock Absorbers, Front & Rear	11
Assemblies - General Information, H.P. & Torque	6, 7	Spark Plugs	12
Assemblies - Lubrication	6, 7	Speedometer	20, 21
Assemblies - Power Trains	3	Springs - Front & Rear Suspension	3
Assemblies - Exhaust System	22	Valve, Engine	20, 21
Assemblies - Lubrication Availability	5	Stabilizer (Sway Bar) - Front & Rear	10
Assemblies - Cooling	7, 8	Starting Motor	20, 21
Assemblies - Filters - Engine Oil, Fuel System	19	Steering	11
Assemblies - Ignition	19, 20	Suppression - Ignition, Radio	19, 20, 21
Assemblies - Fuel Pump, Fuel System	1, 2, 8	Suspension - Front & Rear	12
Assemblies - Fuel Injection	1, 8	Switches	6
Assemblies - Fuses, Circuit Breakers	14	Tailpipe	6
Assemblies - Generator and Regulator	10	Thermostat, Cooling	5, 6, 11
Assemblies - Ignition	22	Timing, Engine & Valve	15
Assemblies - Lamps	14	Tires	17
Assemblies - Headroom - Body	1	Tire Inflation	16
Assemblies - Weight - Overall	12	Torque Converter	1, 2, 2
Assemblies - Horsepower - Brake	1, 2, 3	Torque - Engine, Rated	1, 3, 8, 15, 16
Assemblies - Ignition System	11	Transmission - Types	1, 3, 8, 15, 16
Assemblies - Ignition - Tires	7, 12	Automatic	1, 3, 8, 15, 16
Assemblies - Instruments	21	Manual & Overdrive	1, 3, 8, 15, 16
Assemblies - Ignition (Steering Axis)	13	Ratios	15, 16
Assemblies - Lamp Bulbs	14	Tread	1a
Assemblies - Weight & Spacing	1a	Trunk Luggage Capacity	20
Assemblies - Ignition	1	Turning Diameter	19
Assemblies - Ignition - Overall	5	Unitized Construction	16, 17
Assemblies - Ignition, Valve	5	Universal Joints, Propeller Shaft	7, 8
		Valves - Intake & Exhaust	5, 6
		Vibration Damper	10
		Voltage Regulator	9
		Water Pump	7, 8
		Weights - Shipping, Curb	21
		Wheel Alignment	1
		Wheelbase	8
		Wheels & Tires	21
		Wheel Spindle	1
		Widths - Car & Body	1
		Windshield	1
		Windshield Wiper	1

AMA Specifications — Passenger Car

30

Page

MAKE OF CAR CORVETTE MODEL YEAR 1965 DATE ISSUED 2-22-65 REVISED(•)

GENERAL SPECIFICATIONS

(All dimensions in inches unless otherwise indicated)

MODEL	19400	Additional Information Page No.:	396 Cu. In. V-8 Engine 425 HP	
Wheelbase (L101)		23	98.0	
Tread	Front (W101)	22	56.8	
	Rear (W102)	22	57.6	
Maximum Overall Dimensions	Length (L103)	23	175.1	
	Width (W103)	22	69.6	
	Height (H101)	24	19437 49.6	19467 49.8
Transmission— (Specify trade name - opt., not available)	Manual	15	Synchromesh; 4-Speed Opt.	
	Overdrive	16	NA	
	Automatic	16	NA	
Axle ratio	Manual	17	3.36:1 (Positraction only)	
	Overdrive	17	NA	
	Automatic	17	NA	
Tire size		18	7.75 x 15	
Engine	Type, no. cyl., valve arr.	2	90° OHV V-8	
	Fuel system (Carb., other)	B	Carburetor	
	Bore and stroke	2	4.094 x 3.76	
	Piston displ., cu.in.	2	396 Cu. In.	
	Std. compression ratio	2	11.0:1	
	Max. bhp at engine rpm	2	425 @ 6400	
	Max. torque at rpm	2	415 @ 4000	

MAKE OF CAR CORVETTE MODEL YEAR 1965 DATE ISSUED 2-22-65 REVISED (e)

GENERAL SPECIFICATIONS — DIMENSIONS

(All dimensions in inches unless otherwise indicated)
(Supplemental data available on request)

MODEL	19400	Ref. No.	19437	19467
-------	-------	----------	-------	-------

FRONT COMPARTMENT

Shoulder room	W3		48.4	
Max. eff. leg room - accelerator	L34		42.7	
Effective head room	H61	37.0		38.5
H Point to Heel point	H30		3.9	
Upper body opening to ground	H50	46.8		45.6

REAR COMPARTMENT NA

Shoulder room	W4			
H Point couple distance	L50			
Minimum effective leg room	L51			
Effective head room	H63			

STATION WAGON—THIRD SEAT NA

Shoulder room	W85			
Effective leg room	L86			
Effective head room	H86			

LUGGAGE COMPARTMENT

Usable luggage capacity (See instr.)	V1	10.6 cu. ft.	8.1 cu. ft.
Liftover height	H195		NA
Position of spare tire storage		Under fuel tank (accessible from underside of vehicle)	
Method of holding lid open			NA

STATION WAGON—CARGO SPACE NA

Minimum distance between wheel houses at floor level	W201		
Rear end opening width at belt	W204		
Floor length from back of front seat at floor level to inside of closed tail gate	L202		
Minimum horizontal distance from top rear of front seat back to inside of tail gate at belt	L204		
Maximum height - floor covering to headlining at centerline of rear axle	H201		
Maximum height of rear opening - tail and lift gates open	H202		
Cargo volume index (cu.ft.)	$\frac{W4 \times L204 \times H201}{1728}$	V2	

AMA Specifications—Passenger Car

MAY OF CAR CORVETTE **MODEL YEAR** 1965 **DATE ISSUED** 2-22-65 **REVISED** (e)

MODEL 396 Cu. In. V-8 Engine 425 HP

ENGINE—GENERAL

Type, no. cyls., valve arr.		90° OHV V-8
Bore and stroke (nominal)		4.094 x 3.76
Piston displacement, cu. in.		396 Cubic Inch
Bore spacing (C/L to C/L)		4.84
No. system (front to rear)	L. Bank	1-3-5-7
	R. Bank	2-4-6-8
Firing order		1-8-4-3-6-5-7-2
Compres. ratio (nominal)		11.0:1
Cylinder Head Material		Cast alloy iron
Cylinder Block Material		Cast alloy iron
Cylinder Sleeve—Wet, dry, none		None
Number of mounting points	Front	Two
	Rear	One
Engine installation angle		3°
Taxable horsepower	Diag. 2 x No. Cyl. 2.5	53.6
Published max. bhp* @ eng. RPM		425 @ 6400
Published max. torque* (lb. ft. @ RPM)		415 @ 4000
Recommended fuel —gular — premium		Premium
Idle speed (spec. neutral or drive)	Manual	700
	Automatic	

ENGINE—PISTONS

Material		Aluminum impact extruded	
Description and finish		Domed head, slipper skirt	
Weight (piston only) oz.		24.00	
Clearance (limits)	Top land	.0265 - .0335	
	Skirt	Top	.0044 - .0053 (a)
		Bottom	
Ring groove depth	No. 1 ring	.2228 - .2243	
	No. 2 ring	.2228 - .2243	
	No. 3 ring	.2118 - .2128	
	No. 4 ring		

*Max. bhp (brake horsepower) and max. torque corrected to 60° F and 29.92 in. Hg atmospheric pressure.

(a) Measured 2.13 from top of piston.

AMA Specifications – Passenger Car

MAKE OF CAR CORVETTE MODEL YEAR 1965 DATE ISSUED 2-22-65 REVISED(a) _____

POWER TEAMS

(Indicate whether standard or optional)

MODEL AVAILABILITY	ENGINE					TRANSMISSION	AXLE RATIO** (Std. first)			
	Displ. cu. in.	Carburetor	Compr. Ratio	BHP @ RPM	Torque @ RPM		A	B	C	D
19400	396 *	4-Bbl	11.0:1	425 @ 6400	415 @ 4000	4-Speed * 4-Speed Hvy.Dty*	3.36:1	4.11:1	3.70:1 3.55:1	3.08:1 4.00:1

- * - Optional
- ** - Available as positraction only
- A - General Purpose (Standard)
- B - Special Purpose or Mountain
- C - Performance Cruise
- D - High Performance

AMA Specifications – Passenger Car

MAKE OF CAR CORVETTE **MODEL YEAR** 1965 **DATE ISSUED** 2-22-65 **REVISED** (*)

MODEL 19400 396 Cu. In. V-8 Engine 425 HP

ENGINE—RINGS

Function (top to bottom)	No. 1, oil or comp.	Compression
	No. 2, oil or comp.	Compression
	No. 3, oil or comp.	Oil Control
	No. 4, oil or comp.	---
Compression	Description - material, type, coating, etc.	Cast alloy iron; inside bevel Molybdenum coating
	Width	.0620-.0625
	Gap	.010-.020
Oil	Description - material, type, coating, etc.	Multi-piece (2 rails and one spacer expander) Rails - Steel chrome plated OD Expander - Stainless steel
	Width	.1890-.1910 assembled
	Gap	.010-.030
Expanders		In oil ring assembly

ENGINE—PISTON PINS

Material	Chromium Steel	
Length	2.930-2.950	
Diameter	.9895-.9898	
Pin	Locked in rod, in piston, floating, etc.	Locked in rod
	Bushing	In rod or piston None
		Material None
Clearance	In piston	.00045-.00055
	In rod	----
Direction & amount offset in piston		On center

ENGINE—CONNECTING RODS

Material	Drop forged steel	
Weight (oz.)	30.00	
Length (center to center)	6.134-6.136	
Bearing	Material & Type	Premium Aluminum
	Overall length	.857
	Clearance (limits)	.0007-.0028
	End play	.0016-.0020

MAKE OF CAR CORVETTE MODEL YEAR 1965 DATE ISSUED 2-22-65 REVISED (*)

19400

396 Cu. In. V-8 Engine 425 HP

MODEL

ENGINE—CRANKSHAFT

Material		Forged steel		
Vibration damper type		Rubber mounted inertia damper		
End thrust taken by bearing (No.)		Five		
Crankshaft end play		.006-.010		
Main bearing	Material & type	Premium aluminum except No. 5 sintered copper nickel backed babbitt		
	Clearance	#1-4 .0006-.0022; #5 .0017-.0033		
	Journal dia. and bearing overall length	No. 1	2.7506 x .992	
		No. 2	2.7506 x .992	
		No. 3	2.7506 x .992	
		No. 4	2.7506 x .992	
		No. 5	2.7513 x 1.2525	
No. 6		---		
No. 7	---			
Dir. & amt. cyl. offset		None		
Crankpin journal diameter		2.199-2.200		

ENGINE—CAMSHAFT

Location		In block above crankshaft	
Material		Cast alloy iron	
Bearings	Material	Steel backed babbitt	
	Number	Five	
Gear or chain		Chain	
Crankshaft gear or sprocket material		Steel sprocket	
Camshaft gear or sprocket material		Cast aluminum sprocket	
Type of Drive	Timing chain	No. of links	50
		Width	.880
		Pitch	.500

ENGINE—VALVE SYSTEM

Hydraulic lifters (Std, opt, NA)		NA	
Valve rotator, type (Intake, exhaust)		None	
Rocker ratio		1.70:1	
Operating tappet clearance (indicate hot or cold)	Intake	.020	
	Exhaust	.020	
Timing marks on flywheel, damper, other		Harmonic Balancer	

(Continued)

AMA Specifications—Passenger Car

MAKE OF CAR CORVETTE MODEL YEAR 1965 DATE ISSUED 2-22-65 REVISED (*)

MODEL 19400 396 Cu. In. V-8 Engine 425 HP

ENGINE—VALVE SYSTEM (cont.)

Timing (A)	Intake	Opens (°BTC)	54°
		Closes (°ABC)	102°
		Duration - deg.	336°
	Exhaust	Opens (°BBC)	102°
		Closes (°ATC)	54°
		Duration - deg.	336°
Valve opening overlap		108°	
Intake	Material		Alloy steel - Aluminized face
	Overall length		5.204-5.224
	Actual overall head dia.		2.185-2.195
	Angle of seat & face		46° (seat) 45° (face)
	Seat insert material		None
	Stem diameter		.3715-.3722
	Stem to guide clearance		.0010-.0027
	Lift (@ zero lash)		.5197
	Outer spring press. and length	Valve closed (lb. @ in.)	94-106 @ 1.88
		Valve open (lb. @ in.)	303-327 @ 1.38
	Inner spring press. and length	Valve closed (lb. @ in.)	Spring Damper
		Valve open (lb. @ in.)	Spring Damper
Exhaust	Material		High Alloy Steel - Aluminized face
	Overall length		5.345-5.365
	Actual overall head dia.		1.715-1.725
	Angle of seat & face		46° (seat) 45° (face)
	Seat insert material		None
	Stem diameter		.3710-.3717
	Stem to guide clearance		.0015-.0032
	Lift (@ zero lash)		.5197
	Outer spring press. and length	Valve closed (lb. @ in.)	94-106 @ 1.88
		Valve open (lb. @ in.)	303-327 @ 1.38
	Inner spring press. and length	Valve closed (lb. @ in.)	Spring Damper
		Valve open (lb. @ in.)	Spring Damper

ENGINE—LUBRICATION SYSTEM

Type of lubrication (splash, pressure, etc.)	Main bearings	Pressure
	Connecting rods	Pressure
	Piston pins	Splash
	Camshaft bearings	Pressure
	Tappets	Pressure
	Timing gear or chain	Centrifugally oiled from camshaft bearing
	Cylinder walls	Pressure, jet cross sprayed

A - Includes lash of .020 for intake & exhaust.

(Continued)

AMA Specifications – Passenger Car

MAKE OF CAR CORVETTE **MODEL YEAR** 1965 **DATE ISSUED** 2-22-65 **REVISED** (9)

MODEL 19400 396 Cu. In. V-8 Engine 425 HP

ENGINE—LUBRICATION SYSTEM (cont.)

Oil pump type	Gear
Normal oil pressure (lb. @ engine rpm)	50-75 @ 2000
Oil pressure sending unit (elect. or mech.)	Mechanical (direct pressure to Bourdon tube)
Type oil intake (floating, stationary)	Stationary
Oil filter system (full flow, partial, other)	Full Flow
Filter replacement (element, complete)	Element
Capacity of crankcase, less filter-refill (qt.)	5
Oil grade recommended (SAE viscosity and temperature range)	32° F and Above ----- SAE 20W, SAE 20 or SAE 10W-30 0° F and Above ----- SAE 10W or SAE 10W-30 Below 0° F ----- SAE 5W or SAE 5W-20
Engine Service Requirement (MM, MS, etc.)	MS or DG

ENGINE—EXHAUST SYSTEM

Type (single, single with cross-over, dual, other)	Dual
Muffler No. & type (reverse flow, straight thru, separate resonator)	Two, reverse flow
Exhaust pipe dia. (O.D.)	-----
Branch wall thickness) Main	2.50 x .072-.092
Tail pipe diameter (O.D. & wall thickness)	2.00 x .023

ENGINE—CRANKCASE VENTILATION SYSTEM

	Type (ventilates to atmos., induction system, other)	Standard	Induction system
		Optional	
Control unit	Make and model		Carburetor base
	Location		Carburetor air stream
	Energy source (manifold vacuum, carburetor air stream, other)		Carburetor air stream
Complete system	Control method (variable orifice, fixed orifice, other)		Fixed orifice
	Discharges (to intake manifold, carb. air intake, air cleaner intake, other)		Intake manifold
	Air inlet (breather cap, carburetor air cleaner, other)		Filtered side of air cleaner
	Flame arrestor (screen, check valve, other)		Screen

AMA Specifications— Passenger Car

MAKE OF CAR CORVETTE MODEL YEAR 1965 DATE ISSUED 2-22-65 REVISED (a)

MODEL 19400 396 Cu. In. V-8 Engine 425 HP

ENGINE—FUEL SYSTEM

(See Supplement to Page 8 for Details of Fuel Injection, Supercharger, etc. If used)

Induction type: Carburetor, fuel injection, supercharger.		Carburetor	
Fuel Tank	Capacity (gals.)	20 (a)	
	Filler location	Center at rear deck	
Fuel Pump	Type (elec. or mech.)	Mechanical	
	Locations	Lower right front of engine	
	Pressure range	5.25-6.50 PSI	
Vacuum booster (std., optional, none)		None	
Fuel Filter	Type	Fine mesh plastic strainer in gas tank and	
	Locations	In-line paper element between carburetor & fuel line	
Carburetor	Choke type	Automatic	
	Intake manifold heat control (exhaust or water)	Exhaust	
	Air enr. type	Standard	Oil-wetted paper element
		Optional	

CARBURETOR SUPPLEMENTARY INFORMATION

Model Usage	Engine Displ.	Transmission	Carburetors		No. Used and Type	Barrel Size
			Make	Model		
19400	396	4-Speed	Holley	3868826	One; 4 Bbl Down-draft	1.686 Primary & Secondary

(a) - 36 gallon fiberglass tank available optionally

AMA Specifications – Passenger Car

Page

MAKE OF CAR CORVETTE **MODEL YEAR** 1965 **DATE ISSUED** 2-22-65 **REVISED** (e)

MODEL 19400 396 Cubic Inch V-8 Engine 425 HP

ENGINE—COOLING SYSTEM

Type system (pressure, pressure vented, atmospheric, other)		Pressure with surge tank	
Radiator cap relief valve pressure		15 ± 1PSI	
Circulation thermostat	Type (choke, bypass)	Choke	
	Starts to open at (°F)	177° - 183° F	
Water pump	Type (centrifugal, other)	Centrifugal	
	GPM @ 1000 pump rpm	82 @ 5200	
	Number of pumps	One	
	Drive (V-belt, other)	V-Belt	
Bearing type		Double row ball	
By-pass recirculation type (internal, external)		External	
Radiator core type (cellular, tube and fin, other)			
Cooling system capacity	With heater (qt.)	22	
	Without heater (qt.)	21	
	Opt. equipment-specify (qt.)		
Water jackets full length of cylinder (yes, no)		Yes	
Water all around cylinder (yes, no)		Yes	
Radiator hose	Lower	Number and type (molded, straight)	One, molded
		Inside diameter	1.75
	Upper	Number and type (molded, straight)	One, molded
		Inside diameter	1.50
	By-pass	Number and type (molded, straight)	One, molded
		Inside diameter	.725 - .765
Fan	Number of blades & Spacing		5. Staggered
	Diameter		17.00
	Ratio-fan to crankshaft rev.		.949:1
	Fan cutout type		Thermo-modulated - viscous coupling
	Bearing type		Double row ball
*Drive belts (indicate belt used by letter)	Fan		A
	Generator		A
	Water Pump		A
	Power Steering		
Air Conditioning			

* Drive Belt Dimensions	A
Angle of V	38° - 42°
Nominal length (SAE)	55.25
Width	.380 ± .005

AMA Specifications – Passenger Car

MAKE OF CAR CORVETTE MODEL YEAR 1965 DATE ISSUED 2-22-65 REVISED (*)

MODEL 19400 396 Cu. In. V-8 Engine 425 HP

ELECTRICAL—SUPPLY SYSTEM

Battery	Make and Model	Delco-Remy #1980558		
	Voltage Rtg. & Total Plates	12 Volt-66 Plate		
	SAE Designation & Amp Hr. Rtg	61 Amp/Hr. @ 20 Hr. rate		
	Location	Right rear engine compartment		
	Terminal grounded	Negative		
Generator	Make	Delco-Remy		
	Model	#1100696		
	Type	Diode rectified		
	Ratio—Gen. to Cr/s rev.	2.46:1		
	Gen. cut-in (hot)—engine rpm			
Regulator	Make	Delco-Remy		
	Model	1119515		
	Type			
	Cutout relay	Closing voltage @ generator rpm		
		Reverse current to open		
	Regulated	Voltage	13.8-14.8 @ 85° F	
		Current		
	Voltage test conditions	Temperature	Operating	
Load		3-8 amp		
Other		None		

ELECTRICAL—STARTING SYSTEM

Starting motor	Make	Delco-Remy		
	Model	#1107352		
	Rotation (drive end view)	Clockwise		
	Engine cranking speed			
	Test conditions	Engine at operating temperatures		
	Lock test	Amps		
		Volts		
		Torque (lb. ft.)		
No load test	Amps	65-100		
	Volts	10.6		
	RPM (min.)	3600-5100		
Motor control	Switch (solenoid, manual)	Solenoid		
	Starting procedure	<p>SYNCHROMESH- Place gearshift in neutral & depress clutch to floor</p> <p>INITIAL START- Press accelerator pedal to floor once to set automatic choke, then release. Turn ignition to START-release as soon as engine starts.</p>		

(Continued)

AMA Specifications – Passenger Car

MAKE OF CAR CORVETTE **MODEL YEAR** 1965 **DATE ISSUED** 2-22-65 **REVISED** ^(*)

MODEL 19400 396 Cubic Inch V-8 Engine 425 HP

ELECTRICAL—STARTING SYSTEM (cont.)

Motor Drive	Engagement type		Positive shift solenoid
	Pinion meshes (front, rear)		Rear
	Number of teeth	Pinion	9
		Flywheel	153
Flywheel tooth face width		.4010-.4130	

ELECTRICAL—IGNITION SYSTEM

Coil	Make		Delco-Remy
	Model		1115210
	Amps	Engine stopped	4.0
		Engine idling	1.8
Distributor	Make		Delco-Remy
	Model		1111104
	Cent'fgal adv. in crankshaft degrees @ engine rpm (nominal)	Start (rpm)	1000
		Intermediate points deg. @ rpm	
		Max deg. @ rpm	28° @ 4400
	Vacuum adv. in crankshaft degrees @ in. Hg. (nominal)	Start (in Hg)	0° @ 8 In.
		Intermediate points, deg @ in Hg	
		Max. deg. in. Hg.	15° @ 15.5 In.
	Breaker gap (in.)		.019
	Cam angle (deg.)		28°-32°
Breaker arm tension (oz.)		19-23	
Timing	Crankshaft deg. @ rpm.		10° @ 700 rpm
	Mark location		Harmonic Balancer
	Cylinder numbering system (see page 2)		Left bank 1-3-5-7
			Right bank 2-4-6-8
Firing order (see page 2)		1-8-4-3-6-5-7-2	
Spark Plug	Make and model		AC43N
	Thread (mm)		14
	Tightening torque (lb. ft.)		25
	Gap		.033 - .038
Cable	Conductor type		Linen core impregnated with conducting material
	Insulation type		Rubber with neoprene jacket
	Spark plug protector		Silicone





ELECTRICAL—SUPPRESSION

Locations & type	Non-metallic high tension cables
-----------------------------	-------------------------------------

AMA Specifications – Passenger Car

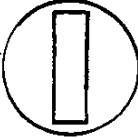
MAKE OF CAR CORVETTE **MODEL YEAR** 1965 **DATE ISSUED** 2-22-65 **REVISED** (*)
 t. 96 Cu. In. engine, L78
MODEL 19400 19437 19467

ELECTRICAL—INSTRUMENTS AND SWITCHES

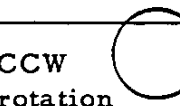
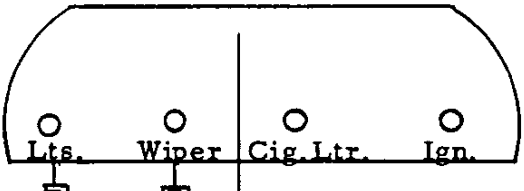
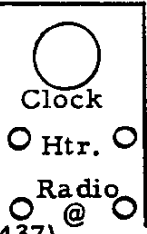
Speedometer	Make	AC			
	Trip odometer (yes, no)	Yes			
Charge indicator—type		Ammeter			
Temperature indicator—type		Electric gage			
Oil pressure indicator—type		Bourdon tube gage			
Fuel indicator—type		Electric gage			
Other		Mechanical tachometer			
Ignition switch	Identify positions in order and circuits controlled	ACCESSORY OFF ON START 	ACCESSORY—Accessories(ign.off) OFF - off, locked ON - ignition, batt., accessories START - starter motor, spring return to ON.		
	Provision for illumination	1-1445 lamp			
	Location	Instrument panel to right of steering column			
Main lighting switch	Identify positions and lamps controlled	 1st position	 2nd position	 CW rotation	 CCW rotation
		Instru. panel lamps parking, tail, and license lamps.	Instru. panel lamps, headlamps, tail & license lamps.	Instru. panel lamps dim to off.	Instru. panel lamps off to bright; full
Other light switches	Locations and lamps controlled	Dimmer; toe panel - hdlp. beam and indicator. Turn signal; steering column - indicators and exterior lamps. Door jam; hinge pillars - dome and/or courtesy lamps. Stop; at brake pedal pendant - exterior stop lamps. Parking brake alarm; parking brake lever - parking brake alarm indicator. Glove compt. illumination; glove compt. - glove compt. lamp.			
Other switches	Locations and devices controlled				
		Hdlp. Mtr. Rr. Compt. Vent Motor (19437)			@ Electric windows - center console. @ Backup lamps - transmission
Windshield wiper	Make	Delco			
	Type	Electric two speed			
	Vacuum booster provision	None			
	Washer provision	Coordinator and vacuum reserve tank			
Horn	Type	Vibrator			
	Number used	2			
	Amp draw (each)	8.00-11.0 @ 12.5V			

@ OPTIONAL EQUIPMENT: radio; backup lamps; power windows;

AMA Specifications – Passenger Car

MAKE OF CAR	CORVETTE	MODEL YEAR	1965	DATE ISSUED	2-22-65	REVISED (e)
Opt. 396 Cu. In. Engine, L78 MODEL 19400			19437		19467	

ELECTRICAL—LAMP BULBS

Give quantity used and trade number, e.g., Headlamp 2-5400 S, dual headlight 2-4001, 2-4002.

Headlamps & arrangement		Dual horizontal: outer 2-4002; inner 2-4001		
Headlamp beam indicator		1-1445		
Parking		2-1157		
Tail		4-1157 (a)		
Stop		4-1157 (a)		
Direction signal	Front	2-1157		
	Rear	4-1157 (a)		
	Indicator	2-1816		
License Plate		1-1155		
Oil pressure and temp. gages		1-"instrument" (shared)		
Charge and fuel gages		1-"instrument" (shared)		
Instrument		7-1816		
Clock		2-1816		Std.
Radio		1-1893		Opt.

Indicate also whether the following lamp assemblies are standard equipment, optional, or NA.

Ignition lock	1-1445			Std.
Back up	2-1156			Opt.
Dome	1-90	Std.	NA	
Glove compartment	1-1893			Std.
Prkg. brake signal	1-257			Std.
Luggage compartment	NA			
Underhood	NA			
Courtesy	Instru. panel. 2-90	Std.	Instru. panel. 2-90; rr. compt. 1-90	Std.
Air cond. controls	1-1893			Opt.
Hdlp. position indicator	1-257			Std.
Heater controls	1-1893			Std.
Cig. lighter	1-1445			Std.
Spot lamp (portable)	1-4416			Opt.

(a) Two with backup lamps

AMA Specifications – Passenger Car

MAKE OF CAR CORVETTE **MODEL YEAR** 1965 **DATE ISSUED** 2-22-65 **REVISED** (e)
 t. 396 Cu. In.
 Engine, L78
MODEL 19400

ELECTRICAL—FUSE & CIRCUIT BREAKER DATA

Use trade number of fuse, e.g., SFE-10. Indicate circuit breaker by ampere capacity suffixed by letters "C.B.", e.g., 30 C.B. Where fuse or circuit breaker protects multiple circuits indicate first use by a letter and repeat the same letter for all units protected by the same fuse or circuit breaker, e.g., Parking lamp SFE-10 (a), Direction indicator same as (a).

Headlamp	15 CB	(a)	Power windows	40 CB
Headlamp beam indicator		(a)	W/S wiper	14 CB
Parking lamp		(a)	Air conditioning	Two AGC 30 one in "(f)"
Tail lamp	AGC 10	(b)	Rr. compt. vent motor	(f)
Stop lamp	AGC 15	(c)		
Direction indicator	AGC 4	(d)		
License plate lamp		(b)		
Instrument lamp		(d)		
Ignition lamp		(d)		
Back up lamp		(b)		
Dome lamp		(c)		
Clock		(c)		
Clock lamp		(d)		
Radio	AGC 2.5	(e)		
Glove compartment lamp		(c)		
Cig. lighter		(b)		
Cig. lighter lamp		(d)		
Courtesy lamps		(c)		
Heter	AGC 10	(f)		
er controls lamp		(d)		
Temp. gage	AGC 10	(g)		
Fuel gage		(g)		
Park. brake alarm		(g)		
Hdtps. motor	40 CB	(h)		
Hdtps. position ind.		(h)		

ELECTRICAL—LOCATION OF OUTSIDE LAMPS

Height above ground to center of bulb	Tail	Lowest	21.76
		Highest	21.76
	Stop	21.76	
	Backup	21.76 (replace inboard tail lamps)	
	License, rear	21.30	
	Directional	Front	15.05
		Rear	21.76
Headlamp	Inside	24.36	
	Outside*	24.36	
Distance from C/L of car to center of bulb	Tail	Inside	19.00
		Outside	24.00
	Stop	19.00 and 24.00	
	Backup	19.00 (replace inboard tail lamps)	
	License, rear	.32	
	Directional	Front	28.32
		Rear	19.00 and 24.00
Headlamp	Inside	15.36	
	Outside*	21.66	

* If single headlamps are used enter here.

AMA Specifications – Passenger Car

MAKE OF CAR CORVETTE MODEL YEAR 1965 DATE ISSUED 2-22-65 REVISED (*)

19400 Opt. 396 Cu. In.

MODEL Engine, L78

DRIVE UNITS—CLUTCH (Manual Transmission)

Make & type	Chevrolet, single dry disc, centrifugal	
Type pressure plate springs	Diaphragm; bent finger design	
Effective plate pressure (lb.)	2300-2600	
No. of clutch driven discs	One	
Clutch facing	Material	Woven type asbestos
	Outside & inside dia.	10.40 & 6.50
	Total eff. area (sq.in.)	103.5
	Thickness	.135 ea.
	Engagement cushioning method	Flat spring steel between cushions
Release bearing	Type & method of lubrication	Single row ball, packed and sealed
Torsional damping	Methods: springs, friction material	Coil springs

DRIVE UNITS—TRANSMISSIONS

Manual (std. or opt.)	Opt - 4-Speed Required
Manual with overdrive (std. or opt.)	NA
Automatic (std. or opt.)	NA

DRIVE UNITS—MANUAL TRANSMISSION

Number of forward speeds		4	
Transmission ratios	In first	2.20:1	
	In second	1.64:1	
	In third	1.28:1	
	In fourth	1:1	
	In reverse	2.27:1	
Synchronous meshing, specify gears		All forward gears	
Shift lever location		Floor	
Lubricant	Capacity (pt.)	2.5	
	Type recommended	Military Spec. MIL-L-2105-B	
	SAE viscosity number	Summer	SAE 80
		Winter	SAE 80
		Extreme cold	SAE 80

AMA Specifications – Passenger Car

MAKE OF CAR CORVETTE **MODEL YEAR** 1965 **DATE ISSUED** 2-22-65 **REVISED** (*)
400 Opt, 396 Cu. In.
MODEL Engine, L78

DRIVE UNITS—MANUAL TRANSMISSION WITH OVERDRIVE NA

For transmission data see manual transmission section

Overdrive	Type (planetary or other)		
	Manual lockout (yes, no)		
	Downshift accelerator control (yes, no)		
	Minimum cut-in speed		
	Gear ratio		
Lubricant	Capacity (pt.) (Overdrive only)		
	Separate filler (yes, no)		
	Type recommended		
	SAE viscosity number	Summer	
	Winter		
	Ext. cold		

DRIVE UNITS—AUTOMATIC TRANSMISSION NA

Trade name		
Type describe		
Method of Selection (Lever, Push Button or other)		
Selector Pattern		
Number of ratios Selector Pattern and indicate which are used in each selector position		
Max. upshift speeds—drive range		
Max. kickdown speeds—drive range		
Torque convertor	Number of elements	
	Max. ratio at stall	
	Type of cooling (air, water)	
Lubricant	Capacity—refill (pt.)	
	Type recommended	
Special transmission features		

DRIVE UNITS—PROPELLER SHAFT

Number used	One	
Type (exposed, torque tube)	Tubular, exposed	
Outer diameter x length* x wall	Manual transmission	2 x 29.90 x .095
	Overdrive transmission	NA
	Automatic transmission	NA

*Center to center of universal joints, or to centerline of rear attachment.

(Continued)

AMA Specifications – Passenger Car

MAKE OF CAR CORVETTE **MODEL YEAR** 1965 **DATE ISSUED** 2-22-65 **REVISED** (e)

9400 Opt, 396 Cu. In.

MODEL Engine, L78

DRIVE UNITS—PROPELLER SHAFT (cont.)

Inter-mediate bearing	Type (plain, anti-friction)	None
	Lubrication (fitting, prepack)	--
Universal joints	Make	Chevrolet
	Number used	2
	Type (ball and trunion, cross, other)	Cross
	Bearing	Type (plain, anti-friction)
Lubric. (fitting, prepack)		Prepack
Drive taken through (torque tube or arms, springs)		Torque control arms
Torque taken through (torque tube or arms, springs)		Torque control arms

DRIVE UNITS—REAR AXLE

Description (see instructions)	Semi-floating, overhung pinion gear		
Limited Slip differential, type	Dual disc clutches		
Drive Pinion Offset	1.5		
No. of differential pinions	2		
Gear ratios (Std. equip.)	Manual transmission	3.70 (Positraction only) (a)	
	Overdrive transmission	NA	
	Automatic transmission	NA	
Ring gear O.D. (std. ratio)	8.375		
Pinion adjustment (shim, other)	None		
Pinion bearing adj. (shim, other)	Shim		
Wheel bearing type	Taper roller		
Lubricant	Capacity (pt.)	3.7	
	Type recommended	For conventional axles, Military Spec. MIL-L-2105-B	
	SAE viscosity number	Summer	SAE 80
		Winter	SAE 80
		Extreme cold	SAE 80

(a) Refer to page 3 for optional axle ratios that are available

REAR AXLE RATIO TOOTH COMBINATIONS

(See page 3 for axle ratio usage)

Axle ratio	3.70	
No. of teeth	Pinion	10
	Ring gear	37

AMA Specifications – Passenger Car

MAKE OF CAR CORVETTE **MODEL YEAR** 1965 **DATE ISSUED** 2-22-65 **REVISED** (*)
396 Cu. In. Engine,
L78 19400
MODEL

DRIVE UNITS—WHEELS

Type & material		Short spoke disc, steel
Rim (size and flange type)	Std.	15 x 5.5K
	Opt.	15 x 6L, integral ribbed aluminum casting
Attachment	Type (bolt or stud)	15 x 5.5K, bolt; 15 x 6L, adapter and spinner cap
	Circle diameter	4.75
	Number and size	15 x 5.5K, 5 hex nuts, 7/16-20 UNF-2B; 15 x 6L, 2-5/8-8 UN-2B

DRIVE UNITS—TIRES Highway, tubeless, 2-ply blackwall, unless indicated otherwise

Standard (List option below)	Size & ply	7.75 x 15-4PR
	Type - Nylon, etc.	Rayon
Rev/mile at 50 mph.		
Inflation press.(cold)	Front	24
	Rear	24
Optional tires - size and ply		7.75 x 15-4PR rayon, W/W 7.75 x 15-4PR nylon (gold stripe)

BRAKES—SERVICE

Type (duo-servo, disc, balanced, etc.)		Caliper disc, 4-wheel hydraulic
Adjusting (std., opt., N.A.)		None required
Hydraulic system type (single, dual, etc.)		Single
Power brake make & type (remote, integral, etc.)		Delco-Moraine vacuum power unit assists master cylinder; integral
Effective area (sq. in.)*		83.4
Gross lining area (sq. in.)**		86.3
Swept drum area (sq. in.)***		461.2
Percent brake effectiveness—front		65.0
Drum	Diameter	Disc 11.75
		Disc 11.75
Type and material		Cast iron
Wheel cylinder bore	Front	1.875
	Rear	1.375
Master cylinder bore		1.00
Available pedal travel		5.00
Line pressure at 100 lb. pedal load		500
Shoe clearance adjustment		None required

* Excludes rivet holes, grooves, chamfers, etc. (Continued)
 ** Includes rivet holes, grooves, chamfers, etc.
 *** Total swept areas for four brakes:
 Widest lining contact width for each brake x its drum circumference.

MAKE OF CAR CORVETTE MODEL YEAR 1965 DATE ISSUED 2-22-65 REVISED ()
 pt. 396 Cu. In. Engine,
 L78
 MODEL 19400

BRAKES—SERVICE (cont.)

		Bonded or riveted	Bonded	
Brake lining	Front Shoe	Material	Woven asbestos	
		Size (length x width x thickness)	Front wheel	5.96 x 2.21 x .41
			Rear wheel	5.96 x 2.21 x .41
	Segments per shoe	One per wheel		
	Rear Shoe	Material	Woven asbestos	
		Size (length x width x thickness)	Front wheel	5.96 x 2.21 x .41
Rear wheel			5.96 x 2.21 x .41	
Segments per shoe		One per wheel		

BRAKES—PARKING

Type of control	Mechanical	
Location of control	T handle at right of steering column	
Operates on	Rear wheels	
if separate from service brakes	Type (internal or external)	Internal
	Drum diameter	6.5
	Lining size (length x width x thickness)	6.77 x 1.25 x .175 ea.

FRAME or UNITIZED CONSTRUCTION

Type and description All welded, full length, ladder constructed frame with 5 crossmembers. Side rails and intermediate crossmembers box construction; rear crossmember "C" shaped. Front crossmember box-girder construction.

SUSPENSION—GENERAL (See Supplemental page 19 for details on Air Suspension)*

Provision for car leveling	Front and Rear stabilizer bar	
Provision for brake dip control	Mounting angle of front upper control arm	
Provision for acc. squat control	None	
Special provisions for car jacking	Front: 5" forward of front edge of door opening, under frame. Rear: 3" forward of wheel opening, under frame.	
Shock absorber front & rear	Type	Direct, double-acting, hydraulic, with freon envelope.
	Make	Delco
	Piston dia.	1.00
Other special features	Full independent rear suspension (stabilizer included); variable rate front springs	

SUSPENSION—FRONT

Type and description Independent: SLA type with coil spring and concentric shock absorber, and spherically-jointed steering knuckle for each wheel.

* Air Suspension:
 Air spring type
 Compressor data
 type
 make
 drive ratio

Normal operating pressures
 spring rates
 leveling data

(Continued)

AMA Specifications – Passenger Cars

MAKE OF CAR CORVETTE **MODEL YEAR** 1965 **DATE ISSUED** 2-22-65 **REVISED** (*)
3.96 Cu. In. Engine,
L78 19400
MODEL

SUSPENSION FRONT (cont.)

Spring	Type		Coil, variable rate
	Material		Steel alloy
	Size (coil design height & I.D.; bar length x dia.)		8.56 x 3.80 (theo); 168.50 x 6.00 (theo)
	Spring rate (lb. per in.)		195
	Rate at wheel (lb. per in.)		80
	Design load (lb. @ design height)		1380 @ 8.56
Stabilizer	Type (link, linkless, frameless)		Link
	Material & bar diameter		Steel, .875

STEERING

Manual (std., opt., NA)		Std.	
Power (std., opt., NA)			
Adjustable steering wheel (tilt, swing, other)	Type and description	Telescoping steering column, driver adjustable	
	(std., opt., NA)	Optional	
Wheel diameter	Manual	16.0	
	Power	16.0	
Turni--	Outside front	Wall to wall (l. & r.)	41.6
		Curb to curb (l. & r.)	39.9
	Inside rear	Wall to wall (l. & r.)	25.6
		Curb to curb (l. & r.)	25.6
Outside wheel angle with inside wheel at 20°		18.5°	
Manual	Gear	Type	Semi-reversible, recirculating ball nut (a)
		Make	Saginaw
		Ratios	16:1
		Overall	Street, 20.2:1; fast, 17.6:1
	No. wheel turns	Street, 3.4; fast, 2.92	
Power	Type (coaxial, linkage, etc.)		Linkage
	Make		Saginaw
	Gear	Type	Same as manual
		Ratios	16:1
		Overall	17.6:1
	Pump driven by		Crankshaft pulley
	Number wheel turns		2.92
Linkage	Type		Parallelogram
	Location (front or rear of wheels, other)		Rear
	Drag link (trans. or longit.)		None
	Tie rods (one or two)		Two

(a) Designed to provide 3" axial adjustment of steering column.

(Continued)

AMA Specifications – Passenger Car

MAKE OF CAR CORVETTE **MODEL YEAR** 1965 **DATE ISSUED** 2-22-65 **REVISED** (a)

Opt. 396 Cu. In. Engine, L78

MODEL 19400

STEERING (cont.)

Steering Axis	Inclination at camber (deg.)		6-1/2 to 7-1/2
	Bearings (type)	Upper	Ball stud with non-metallic brg. surfaces
		Lower	Ball stud with non-metallic brg. surfaces
	Thrust		None req'd.
Wheel alignment (range and preferred)	Caster (deg.)		P1 to P2 (curb)
	Camber (deg.)		P1/4 to P1-1/4 (curb)
	Toe-in (outside tread-inches)		7/32 to 11/32 total (curb)
Steering spindle & joint type			Steering knuckle with spherical joints
Wheel spindle	Diameter	Inner bearing	1.2493-1.2498
		Outer bearing	.7492-.7497
	Thread size		3/4-20 NEF-3 (modified)
	Bearing type		Taper roller

SUSPENSION—REAR

Type and description			(b)
Drive and torq. taken through (see page 17)			Torque control arms
Spring	Type		Multi-leaf
	Material		Chrome carbon steel
	Size (length x width, coil design height and I.D.; bar length & dia.)		46.36 x 2.25
	Spring rate (lb. per in.)		140
	Rate at wheel (lb. per in.)		123
	Design load (lb. at design height)		1360 @ -.352 camber
	Mounting Insulation type		Rubber mtd. @ diff.; vertical loading only @ shackles
	If leaf	No. of leaves	
Inserts		Type and size	(c)
		Material	Polyethylene with graphite
Shackle (comp. or tens.)		--	
Stabilizer	Type (link, linkless, frameless)		Link
	Material		A.I.S.I. C1085
Track bar type			None

(a) Rear wheel alignment at curb: camber-N5/6 to P1/6; toe-in -0 to 1/8 total.

(b) Full independent with fixed differential, transverse multi-leaf spring, lateral struts and universally-jointed axle shafts, and stabilizer.

(c) 7 liners: 2.25 (width) x 44.58, 39.08, 33.58, 29.08, 24.58, 15.58, 11.08.

AMA Specifications – Passenger Car

Model	CORVETTE	MODEL YEAR	1965	DATE ISSUED	2-22-65	REVISED (e)
Displacement	396 Cu. In. Engine,					
Model	L78 19400		19437			19467

BODY—MISCELLANEOUS INFORMATION

Drs. hinged (front, rear)	Front doors		
	Rear doors	Front	
Type of finish (lacquer, enamel, other)		NA	
Hood counterbalanced (yes, no)		Lacquer	
Hood release control (internal, external)		No	
Vehicle (Serial) No. Location		Internal	
Engine No. Location		1-Right side of hinge pillar cross brace, under glove compt. 2-With engine no.	
Theft protection - type		Front right side of cylinder block	
Vent window control method (crank, friction pivot)	Front	Outside door key locks	
	Rear	Crank	
Seat cushion type	Front	NA	
	Rear	Bucket-polyurethane padding	
	3rd seat	NA	
Seat back type	Front	NA	
	Rear	Bucket-polyurethane padding	
	3rd seat	NA	
Windshield glass type (i.e., single curved - laminated plate)		Single curved-laminated safety plate	
Side glass type (i.e., compound curved - tempered plate, three piece)		19367 soft top-flat flexible plastic, 1 piece 19467 hardtop-curved plexiglass, 1 piece 19437 compound curved-solid safety plate, 1 piece	
Side glass type (i.e., curved - tempered plate)		Compound curved-solid safety plate	
Side glass exposed surface area		620.1	550.1
Windshield glass exposed surface area		789.7	
Backlight glass exposed surface area		821.5	440.5 (soft top)
Total glass exposed surface area		2231.3	1780.3 (soft top)

BODY—CONVENIENCE EQUIPMENT (Indicate whether standard, optional or NA on each series)

Power windows	Side Windows		
	Vent Windows	Optional	
	Backlight or tailgate	NA	
Power seats (specify type as well as availability)		NA	
Reclining front seat back		NA	
Front seat headrest		NA	
Radio (specify type as well as availability)		AM-FM, all models	
Rear seat speaker		NA	
Power Antenna		Included with radio option	
Clock		Standard	
Air Conditioner (specify type and availability)		Four Seasons, all models	

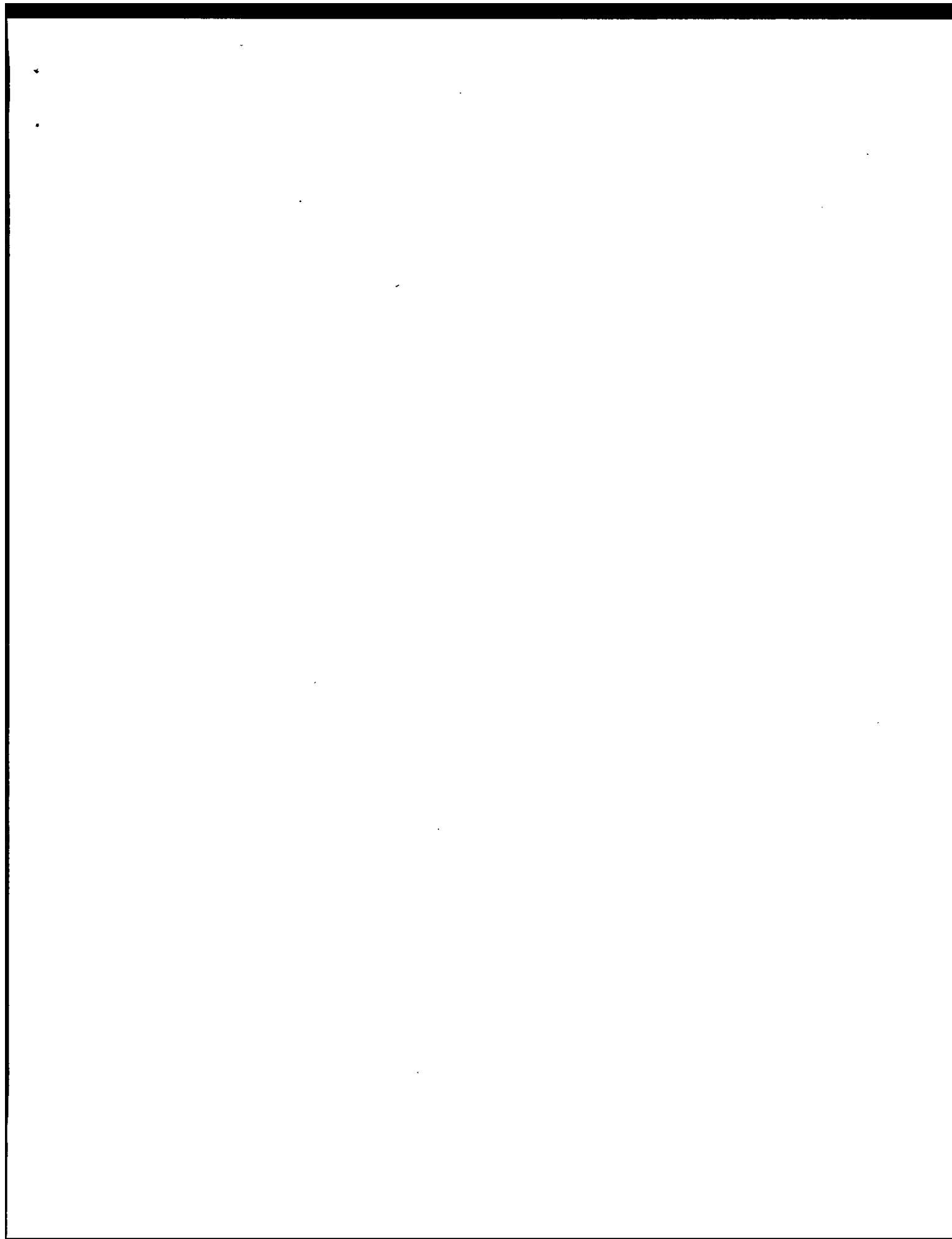

AMA Specifications – Passenger Car

Page 24

INDEX

SUBJECT	PAGE NO.	SUBJECT	PAGE NO.
Automatic Transmission	1, 16	Linings - Clutch, Brake	15, 19
Axis, Steering	21	Lubrication	6, 7, 15, 16, 17
Axle, Rear	1, 17	Luggage Capacity	1a
Battery	10	Motor, Starting	10
Bearings, Engine	4, 5, 6	Muffler	7
Belts - Fan, Generator, Water Pump	9	Overdrive	16
Body - General Information, types	Title, 1, 22	Piston Pins & Rings	2, 4
Exterior Dimensions	1	Pistons	2
Interior Dimensions	1a	Power Brakes	18
Brakes - Parking, Service, Power	18, 19	Power Steering	20
Camber	21	Power Teams	3
Camshaft	5	Propeller Shaft, Universal Joints	16, 17
Capacities		Pumps - Oil, Fuel	7, 8
Cooling System	9	Water	9
Fuel Tank	8	Radiator, Hoses	9
Lubricants		Ratios - Axle	1, 3, 17
Engine Crankcase	7	Compression	1, 2, 3
Transmission and Overdrive	15, 16	Steering	20
Rear Axle	17	Transmission	15, 16
Carburetor	3, 8	Rear Axle	1, 3, 17
Caster	21	Regulator - Generator	10
Choke, Automatic	8	Rims	18
Circuit Breakers, Fuses	14	Rings, Piston	4
Clutch - Pedal Operated	15	Rods - Connecting	4
Coil, Ignition	11	Shock Absorbers, Front & Rear	19
Connecting Rods	4	Spark Plugs	11
Cooling System	9	Speedometer	12
Crankcase Ventilation	7	Springs - Front & Rear Suspension	20, 21
Shaft	5	Valve, Engine	6
Pistons and Cylinder Head	2	Stabilizer (Sway Bar) - Front & Rear	20, 21
Distributor - Ignition	11	Starting Motor	10
Electrical System	10, 11, 12, 13, 14	Steering	20, 21
Engine		Suppression - Ignition, Radio	11
Bore, Stroke, Displacement, Type	1, 2	Suspension - Front & Rear	19, 20, 21
Compression Ratio	1, 2	Switches	12
Firing Order, Cylinder Numbering	2, 11	Tailpipe	7
General Information, H.P. & Torque	1, 2	Thermostat, Cooling	9
Lubrication	6, 7	Timing, Engine & Valve	5, 6, 11
Power Teams	3	Tires	1, 18
Exhaust System	7	Toe in	21
Equipment Availability	22	Torque Converter	16
Fan, Cooling	9	Torque - Engine, Rated	1, 2, 3
Filters - Engine Oil, Fuel System	7, 8	Transmission - Types	1, 3, 8, 15, 16
Frame	19	Automatic	1, 3, 8, 15, 16
Front Suspension	19, 20	Manual & Overdrive	1, 3, 8, 15, 16
Fuel, Fuel Pump, Fuel System	1, 2, 8	Ratios	15, 16
Fuel Injection	1, 8	Tread	1
Fuses, Circuit Breakers	14	Trunk Luggage Capacity	1a
Generator and Regulator	10	Turning Diameter	20
Glass	22	Unitized Construction	19
Height (Lamps)	14	Universal Joints, Propeller Shaft	16, 17
Headroom - Body	1a	Valves - Intake & Exhaust	5, 6
Heights - Overall	1	Vibration Damper	5
Horns	12	Voltage Regulator	10
Horsepower - Brake	1, 2, 3	Water Pump	9
Ignition System	11	Weights - Shipping, Curb	23
Inflation - Tires	18	Wheel Alignment	21
Weights	7, 12	Wheelbase	1
Kingpin (Steering Axis)	21	Wheels & Tires	18
Lamp Bulbs	13	Wheel Spindle	21
Lamp Height & Spacing	14	Widths - Car & Body	1
Legroom	1a	Windshield	22
Lengths - Overall	1	Windshield Wiper	12
Lifters, Valve	5		